



TeamDrive Host Server Installation and Configuration

Release 4.0.6.0

Barry Leslie, Paul McCullagh, Eckhard Pruehs

2023

1	Copyright Notice	1
2	Trademark Notice	3
3	Introduction	5
3.1	Hardware Requirements	5
3.2	Operating System Requirements	5
3.3	Required Skills	6
3.4	Storage Requirements	6
3.5	Network Requirements	6
4	Introduction to the TeamDrive Hosting Service	9
4.1	TeamDrive Hosting Service Overview	9
4.2	TeamDrive Hosting Basics	10
4.3	Directory Structure of Hosted Data	10
4.4	Spaces, Owners, and Depots	14
4.5	Background Tasks Performed by <code>td-hostserver</code>	14
5	Operating System Configuration	15
5.1	Installing a base operating system	15
5.2	Time Synchronization with Chrony NTP Server	15
5.3	Disable SELinux	15
5.4	Firewall configuration	15
5.5	Installing the Postfix MTA (optional)	16
6	Installing the Host Server Components	19
6.1	Enable the TeamDrive Host Server <code>dnf</code> Repository	19
6.2	Download and Install the TeamDrive Host Server Package	19
6.3	Installing the Host Server HTML Documentation (optional)	20
7	Apache HTTP Server Installation and Configuration	21
7.1	Update <code>httpd.conf</code>	21
7.2	Enable “Prefork” Mode	21
7.3	Disable Unneeded Apache Modules	22
7.4	Disable access logs	23
7.5	Configure <code>mod_ssl</code>	23
8	MySQL Installation and Configuration	25
8.1	Installing MySQL Server	25
8.2	Creating TeamDrive MySQL User and Databases	27
8.3	CentOS Hardening	29
9	TeamDrive Server Hardening	31
9.1	CentOS 8 Partition Layout	31
9.2	Service Isolation and Sandboxing	31
9.3	SSH Authentication, Login and Passwords	32

9.4	Kernel adjustments	33
9.5	Filesystem	34
9.6	Network	34
9.7	Firewall	34
9.8	Shell	34
9.9	Disabled services	34
9.10	Package Management and Automatic (Security) Updates	36
9.11	Virus check	37
9.12	Rootkit Scanner	37
9.13	RNG and Entropy	37
9.14	Fail2Ban	37
9.15	fapolicyd	37
9.16	Intrusion Detection (IDS/File Integrity)	38
9.17	DNSCrypt	38
9.18	NTP	38
9.19	Accounting and Auditing	38
9.20	PHP (only Registration Server)	39
9.21	CentOS Hardening Check	39
9.22	Known problems caused by the hardening	39
10	Pre-Installation Tasks	41
10.1	Mount the Space Storage Volume	41
10.2	Replacing the self-signed SSL certificates with proper certificates	42
10.3	Starting the Host Server Instance	42
11	Initial Host Server Configuration	45
11.1	Registering and Activating the Host Server	45
11.2	Setup and Administration	47
11.3	Associating the Host Server with a Provider	50
11.4	Testing Client Access	50
12	Post-Installation Tasks	51
12.1	Startup Sequence / Dependencies	51
12.2	Starting the Apache HTTP Server at Boot Time	51
12.3	Starting TeamDrive Service at Boot Time	51
12.4	Next steps	52
13	Troubleshooting	53
13.1	List of relevant configuration files	53
13.2	List of relevant log files	53
13.3	Enable Logging with Syslog	54
13.4	Tracing Client Accesses to a Single Space	55
13.5	Common errors	56
14	Appendix	61
14.1	Abbreviations	61
15	Release Notes - Version 4.x	63
15.1	Change Log - Version 4.0	63
16	Release Notes - Version 3.x	67
16.1	Change Log - Version 3.7	67
16.2	Change Log - Version 3.6	71
16.3	Change Log - Version 3.5	73
16.4	Change Log - Version 3.0.013	79
16.5	Change Log - Version 3.0.011	83

COPYRIGHT NOTICE

Copyright © 2014-2023, TeamDrive Systems GmbH. All rights reserved.

TeamDrive Systems GmbH

<https://www.teamdrive.com>

Max-Brauer-Allee 50

22765 Hamburg, Germany

Email: info@teamdrive.com

TRADEMARK NOTICE

Linux is the registered trademark of Linus Torvalds in the U.S. and other countries.

Apache HTTP Server, Apache, and the Apache feather logo are trademarks of The Apache Software Foundation.

MySQL is a registered trademark of Oracle and/or its affiliates.

Intel and Intel Xeon are trademarks or registered trademarks of Intel Corporation.

AMD, Opteron, the AMD logo, and the AMD Opteron logo are trademarks or registered trademarks of Advanced Micro Devices.

VMware is a trademark or registered trademark of VMware, Inc. in the United States and/or other jurisdictions.

“Amazon Web Services”, “Amazon S3” are trademarks of Amazon.com, Inc. or its affiliates in the United States and/or other countries.

“Azure” is a trademarks of Microsoft Corporation.

“Red Hat Linux” and “CentOS” are trademarks of Red Hat, Inc. in the U.S. and other countries.

All other names and trademarks used herein are the property of their respective owners.

INTRODUCTION

The TeamDrive Host Server provides the scalable storage component required for TeamDrive Clients to store their Space data.

This manual will guide you through the installation of your own local hosting service for TeamDrive. This document is intended for administrators who need to install and configure a TeamDrive Hosting Service.

Warning: The TeamDrive Host Server installation requires a running TeamDrive Registration Server instance. If you are setting up both components on your own premises, please start with setting up the Registration Server as outlined in the TeamDrive Registration Server installation guides. If you are using a Registration Server instance hosted by some other service provider, make sure you can access it and you have performed an initial setup/configuration already.

3.1 Hardware Requirements

To operate a TeamDrive Hosting Service you need a **64-bit** system with a minimum of 2 processors (or 1 processor with dual-core or quad-core), a minimum of 2 GB RAM and a redundant storage system (e.g. RAID-5) that is sufficiently large and scalable if required.

The exact sizing depends heavily on the anticipated number of concurrent client connections, the bandwidth required and the amount of space data to be stored. Please contact us via sales@teamdrive.net for assistance.

We recommend a quad-core processor with 8 GB RAM.

3.2 Operating System Requirements

We recommend using a recent 64-bit version of **Red Hat Enterprise Linux 6/7** (RHEL 6/7) or a derivative distribution like **CentOS 6/7**, **Oracle Linux 6/7** or **Scientific Linux 6/7** as the operating system platform.

This document is written with this OS environment in mind — the names of packages, configuration files and path names might be different on other Linux distributions. If you have any questions about using other Linux distributions, please contact sales@teamdrive.net.

You will need at least Apache HTTP Server version 2.2.9 (CentOS 6) or 2.4 (CentOS 7) which should be configured using the “prefork” MPM (<http://httpd.apache.org/docs/2.2/mod/prefork.html>). The prefork option is more scalable under load than the worker option and is usually the default configuration on Linux distributions.

The TeamDrive Host Server processes need to open a large number of file descriptors. Make sure that the values in `ulimit` are set sufficiently high, e.g. by setting “nofile — max number of open files” in file `/etc/security/limits.conf`.

In addition, the TeamDrive Hosting Service requires the Yvva Runtime Environment version 1.5.9 or later, and a MySQL Database Server version 5.1 or later (MySQL 5.5 or 5.6 are recommended for performance reasons).

3.3 Required Skills

When installing the TeamDrive Hosting Service, we assume that you have basic knowledge of:

- VMware: importing and deploying virtual machines, configuring virtual networking and storage (when using a pre-installed Virtual Appliance)
- **Linux system administration:**
 - Adding/configuring software packages
 - Editing configurations files
 - Starting/stopping services
 - Creating user accounts
 - Assigning file ownerships and privileges
 - Creating and mounting file systems
 - Setting up environment variables
- Apache Web Server: installation and configuration, adding and enabling modules, modifying configuration files
- MySQL Database: installation and configuration, administration/maintenance, using the MySQL command line client, basic SQL
- Basic knowledge of application server technology

3.4 Storage Requirements

Storage Volumes are used to store the TeamDrive Clients' Space data, so they can grow quite significantly in size. We strongly suggest to place them on a dedicated file system/storage volume or an NFS mount that supports proper file locking (e.g. NFSv4). See preinstall/testing file locking for a description of how to verify file locking on a Storage Volume.

When using a block device like a local/virtual hard disk or an iSCSI target, we suggest using ext3, ext4 or XFS on top of a logical volume (LVM) as the file system for this storage area. Using LVM provides some additional flexibility for increasing the storage capacity of a single volume dynamically.

It should be ensured that the Space storage volumes that are mounted on the servers are equipped with sufficient security measures against failure and data loss. Strategies could include mirrored drives or some form of RAID at the minimum; even better is a SAN system with upstream NAS heads. Alternatively, block-by-block replication (as provided by many enterprise storage systems) can be implemented.

3.5 Network Requirements

The bandwidth of the Host Server's network interface plays a vital role in defining the overall performance and responsiveness of the TeamDrive Service. Clients need to be able to quickly upload new Space data, so it is available for download for all other Clients invited to that Space. Usually, the amount of outgoing traffic (delivering Space data to clients) exceeds the inbound traffic.

The system must have IP connectivity, using a fixed IP address and a resolvable fully qualified domain name. This host name becomes part of the URLs used by the TeamDrive clients to access the TeamDrive Spaces and can not be changed once the service is in operation. The Host Server itself needs to be able to properly resolve host names, too.

If the Host Server is located behind a firewall, please ensure that it is reachable via HTTP (TCP port 80) and HTTPS (TCP port 443) by the TeamDrive Clients.

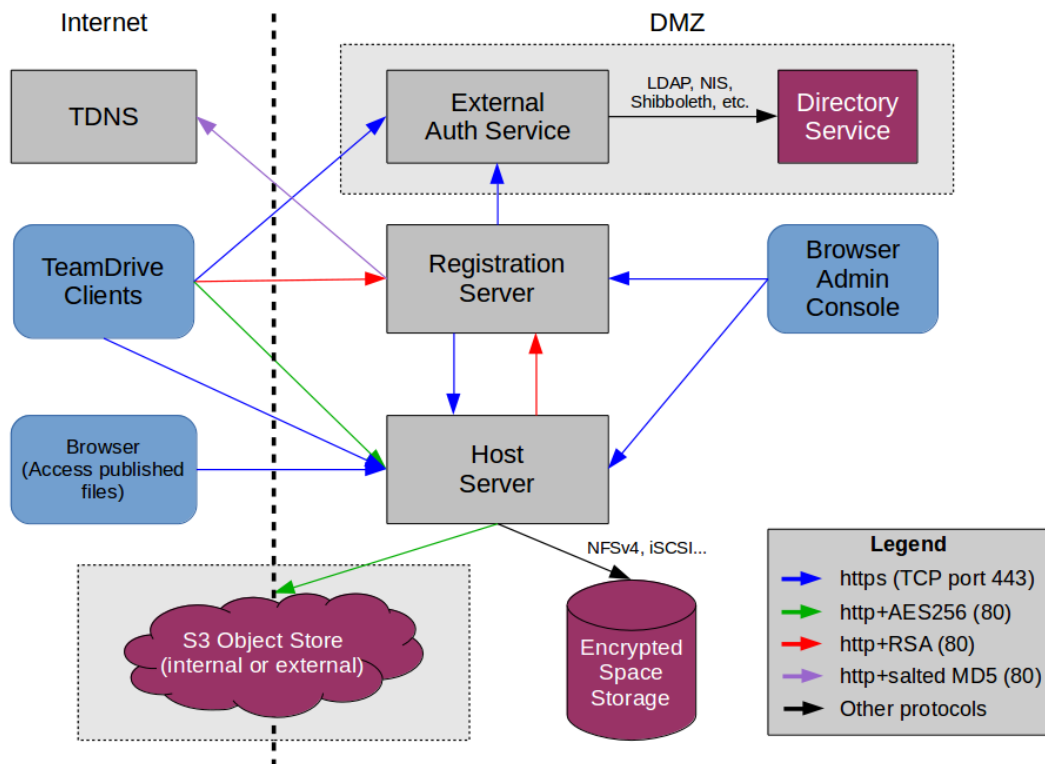

Fig. 3.1: TeamDrive Hosting Service Networking Overview

For the initial registration and the exchange of cryptographic keys, the Host Server must be able to establish HTTP connections (TCP port 80) to the Registration Server. After the registration and activation, no further connections from the Host Server to the Registration Server will be established.

To perform API calls (e.g. to create new Space Depots or to query for existing Spaces for a particular user), the TeamDrive Registration Server must be able to establish outgoing HTTP/HTTPS connections to the TeamDrive Hosting Service.

INTRODUCTION TO THE TEAMDRIVE HOSTING SERVICE

4.1 TeamDrive Hosting Service Overview

The TeamDrive Hosting Service consists of a number of components which are illustrated below:

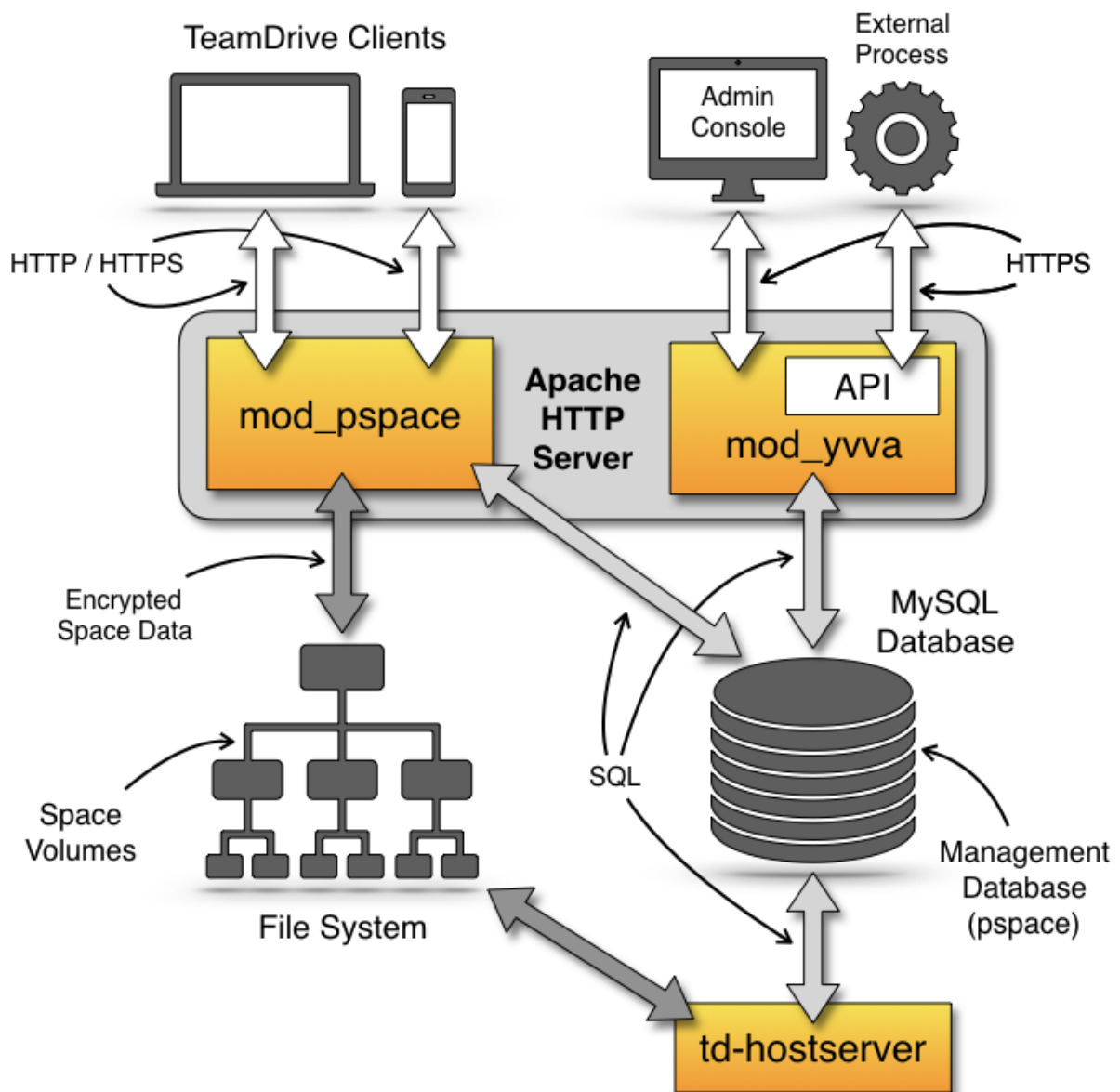

Fig. 4.1: TeamDrive Hosting Service Overview

The TeamDrive Apache module `mod_ospace` handles the communication and exchange of data with the TeamDrive Clients. In the default configuration, Space data is stored on a regular file system or an NFSv4 share.

The TeamDrive Hosting Service Administration Console and TeamDrive Hosting Service API is served by the Yvva Apache module `mod_yvva`.

The list of Spaces, access data, usage statistics and other administrative information is stored in the Management MySQL Database called `ospace`.

Additionally, an Amazon S3/Azure BLOB Storage/Ceph Object Storage-compatible object store can be used as second tier storage. This significantly reduces the load on the first tier storage with regards to disk space utilization and I/O. In this case, only data “in flight” like the files being uploaded by the TeamDrive Clients and the Space log files are stored temporarily on the first tier storage until the upload completed. Only the so-called `last.log` files reside permanently on the first tier storage in this configuration.

Afterwards, the files are moved to the object store asynchronously, using the TeamDrive Daemon `s3d`. Once they have been transferred to the object store, `mod_ospace` fetches the objects in question from there before serving them to the Clients, thus acting as a proxy.

Alternatively, the Hosting Service can be configured in such a way that Clients requesting these objects will receive a redirect to the object store by `mod_ospace` for obtaining them directly. This helps to offload network traffic from the Host Server to the object store.

See the chapter *Setting up an Object Store* in the *TeamDrive Hosting Service Administration Guide* for details.

A storage system combined with the associated web servers is called a TeamDrive Hosting Service. Externally, i.e. from the Registration Server or user’s perspective, the Hosting Service is referred to as a TeamDrive Host Server. However, in this documentation references to TeamDrive Host Server refer to single host instance running an Apache Web Server and the TeamDrive Hosting Service software.

The illustration above shows a “scaled-out” solution, with several Apache Webservers attached to a TeamDrive Scalable Hosting Storage (TSHS) cluster. See the chapter *TeamDrive Scalable Hosting Storage* in the *TeamDrive Hosting Service Administration Guide* for details.

As an alternative to TSHS, a shared file system like NFSv4 or a distributed file system can also be used to store the data.

4.2 TeamDrive Hosting Basics

When using file system based storage, the data is stored on one or multiple volumes. When using the TSHS cluster for storage, the volume component is ignored. When using a file system, Spaces may be created on any volume that is “operational”.

A TeamDrive Hosting Service requires a unique domain name. The domain name becomes part of the Space URL that is returned to the TeamDrive Client when a Space is created on the service. The domain name is also part of the URL used by the clients to create Spaces, and by the Registration Server to create new Space Depots. This URL is stored in the `ServiceHostURL` system setting.

The Same domain name is also used to access Hosting Administration Console Hosting Service API. The default Hosting Administration Console URL is: <https://tdhostserver.yourdomain.com/admin/>

Note: Note that it is not possible to change the domain name of a Host Server, once the TeamDrive Clients have contacted it to create and access Spaces — the location of Spaces is tied to the Host Server’s host name. However, it is possible to change a Host Server’s IP address, if required.

4.3 Directory Structure of Hosted Data

The directory structure for space data stored on local storage is as follows:

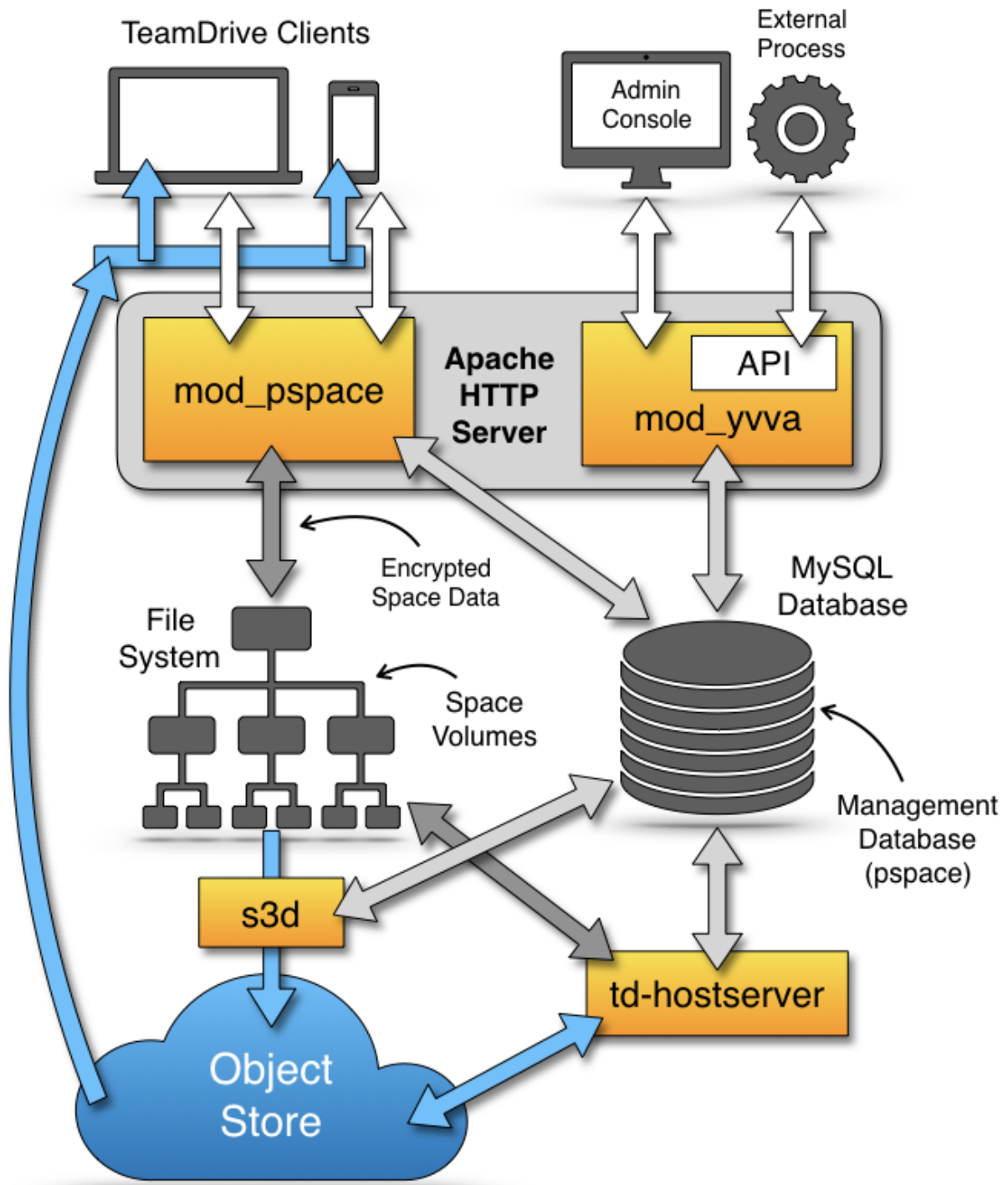

Fig. 4.2: TeamDrive Hosting Service using an object store

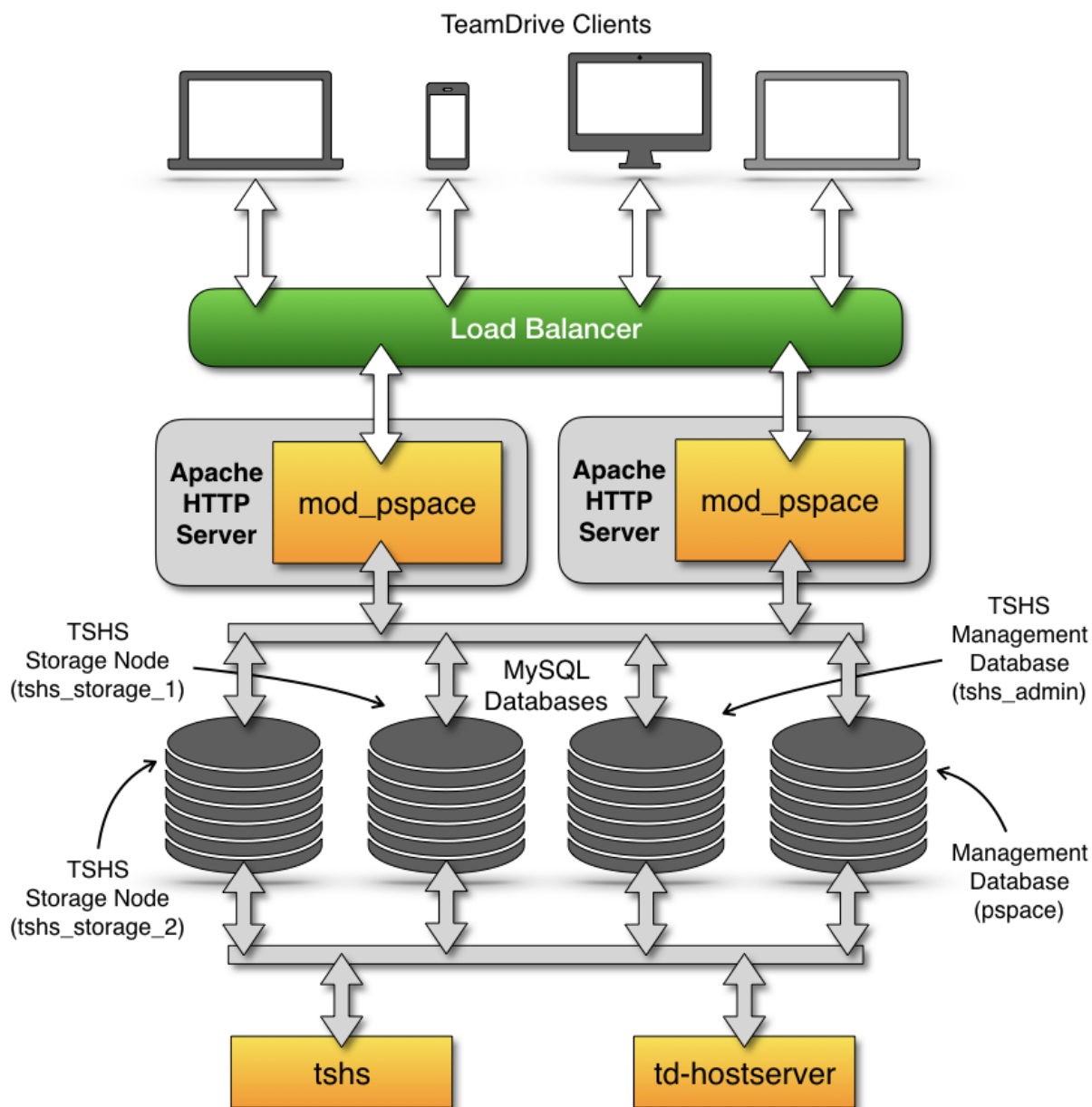

Fig. 4.3: TeamDrive Scalable Hosting Storage (TSHS)

```

spacedata
`-- vol01
  |-- 1
  |   |-- protolog
  |   |   |-- last.log
  |   |   |-- last.log.lock
  |   |   `-- 0.log
  |   `-- data
  |       |-- D41D8CD98F00B204E9800998ECF8427E
  |       |-- 7D0F97FC38AE3B2666435D03AA91F352
  |       `-- 253F19AA30D5346662B3EA83CF79F0D7
  `-- 2
      |-- data
      |   |-- 5ACDD4Z000004004U8RGKHSZM2592M8H
      |   |-- F3XG47Z000004004U8RG1214Z2592M80
      |   `-- NYFBTSZ000004004U8RFT7Q8A2592M7Y
      |-- protolog
      |   |-- last.log
      |   `-- last.log.lock
      |-- public
      |   `-- 8CN7S0800000A004UH0Q9TP323BBNZ8E
      |       `-- Familypicture.jpg
      `-- snapshot
          |-- last.log
          `-- last.log.lock

```

When Spaces are created, they are evenly distributed across individual volumes, based on the relative disk space utilization ratio of each available volume. A Space is identified in the file system by its unique database ID. The TeamDrive Clients store the data for a Space separated according to metadata (`protolog`-directory) and contents (`data`-directory).

Metadata is appended to a log file and reflects the history of the Space by storing all events (invitations of users, creation of directories, files and all modifications, etc.). All data stored on the Hosting Service is encrypted and only the TeamDrive Clients can decrypt it. It is not possible to read the original space data in the log.

New data is continually added to the `data` directory in each Space directory. Existing data is never overwritten, with the exception of data that has not been uploaded fully and where the upload may restart. File names are created using a Global Unique ID algorithm in the TeamDrive Clients that prevents two different clients from creating the same name. When permanently deleting files (e.g. when emptying the recycle bin of a Space), these files are deleted on the server, to free up storage space.

Note: Note that files will not be deleted immediately, if the Point-in-Time Recovery is active for a space. Deleted files are associated with a particular Snapshot, and are only removed when the Snapshot is deleted. For details see `snapshot_backups_and_pit_recovery`.

The `last.log.lock` file in each Space is used internally for providing a reliable locking mechanism to prevent multiple clients from appending data to the `last.log` file at the same time. Hence, the underlying storage or file system needs to support proper file locking (the `mod_space` Apache module depends on `flock` (`LOCK_EX`) to be reliable).

The `public` folder contains unencrypted files that have been published (uploaded) by the TeamDrive Clients. Published files are read-accessible via HTTP or HTTPS (depending on the server configuration) by anybody, including users who do not have a TeamDrive Client installed. A TeamDrive Professional Client license is required to publish files.

Finally, versions 3.2.0 or later of the TeamDrive client support a so-called “Snapshot” feature, which cuts down the time it takes to enter a Space considerably. The information required to implement this functionality is stored in the `snapshot` subdirectory of a Space.

4.4 Spaces, Owners, and Depots

All Spaces created on a host are allocated to a specific Space Depot. A Space Depot has a storage quota and traffic limit. TeamDrive Client users require the access information of a Depot in order to create a Space.

If enabled, the TeamDrive Registration Server creates the necessary Depot (called the default Depot) required by the TeamDrive Client during registration of a client. For this purpose the TeamDrive Registration Server must have API access to the Hosting Service.

After the Depot has been created on the Hosting Service, the access information is returned to the TeamDrive Client via the Registration Server. The default Depot is linked to the registration of the TeamDrive Client, and cannot be used by any other user.

The Space Owner and Space information is recorded when a Space is created using the TeamDrive Client.

In addition to the default Depot, additional Depots can also be created manually via the Registration Server's and the Host Server's Administration Console. See chapter *Manually creating a Depot* in the Host Server Administration Guide for details.

4.5 Background Tasks Performed by `td-hostserver`

The `td-hostserver` process is a service running on a Host Server instance that executes background tasks scheduled by the Hosting Service. It uses the Yvva daemon `yvvad` to run the tasks at regular intervals.

How to start the `td-hostserver` process is described in the section: [starting td-hostserver](#).

A complete description of the tasks performed by `td-hostserver` is provided in the chapter on Hosting Service Management: [hosting service management/auto tasks](#).

OPERATING SYSTEM CONFIGURATION

5.1 Installing a base operating system

Start by performing a minimal OS installation of a recent 64-bit Red Hat Enterprise Linux 6 (RHEL 6) or derivative Linux distribution (e.g. CentOS 6, Oracle Linux 6), using your preferred installation method (manual install, Kickstart, etc). The details of how to perform this task are out of the scope of this document.

For performing the installation, the system needs to be able to establish outgoing TCP connections (mainly to download additional components).

Boot up the system and log in as the root user, either via the console or via an SSH connection.

5.2 Time Synchronization with Chrony NTP Server

We strongly advise that the clocks of all servers in a TeamDrive installation are synchronized using the Network Time Protocol (NTP). For CentOS 8 Chrony will be used and is already installed in general.

For CentOS 8 Chrony will be used instead of NTP. Chrony is already installed in general.

5.3 Disable SELinux

The TeamDrive Host Server currently can not be run when SELinux is enabled. Edit the file `/etc/selinux/config` and set `SELINUX=disabled`.

Reboot the system or change the SELinux enforcing mode at run time using the following command:

```
[root@hostserver install]# setenforce 0
```

5.4 Firewall configuration

You should configure a local firewall so the server is protected against remote attacks. The only TCP ports that should be reachable from outside are 22 (SSH, optional for remote administration), 80 (http) and 443 (https).

On a minimal installation, you can install and use the text-based firewall configuration utility to enable access to the following services:

- SSH
- Secure WWW (HTTPS)
- WWW (HTTP)

To configure the firewall, disable the two unnecessary services:

```
firewall-cmd --remove-service=cockpit --permanent
firewall-cmd --remove-service=dhcpv6-client --permanent
```

and enable HTTP (80) and HTTPS (443):

```
firewall-cmd --zone=public --add-service=http --permanent
firewall-cmd --zone=public --add-service=https --permanent
firewall-cmd --reload
```

Enable additional protections based on your local requirements or security policies.

You can check the result with `firewall-cmd --list-all --zone=public`:

```
[root@webportal ~]# firewall-cmd --list-all --zone=public
public
  target: default
  icmp-block-inversion: no
  interfaces:
  sources:
  services: http https ssh
  ports:
  protocols:
  masquerade: no
  forward-ports:
  source-ports:
  icmp-blocks:
  rich rules:
```

In case of using an external company firewall enable the above ports for the incoming traffic. For outgoing communication please enable:

- Secure WWW (Port 443 for HTTPS)
- WWW (Port 80 for HTTP)
- DNS Lookup (Port 53 for DNS communication with a public DNS server)

5.5 Installing the Postfix MTA (optional)

If you intend to use the email-based two-factor authentication for accessing the Host Server Administration Console, or if you want to be notified about Space Volumes running out of disk space via email, the TeamDrive Host Server needs to be configured to send out these notifications via SMTP.

The Yvva Runtime Environment that provides the foundation for the Host Server is only capable of sending out email using plain SMTP via TCP port 25 to a local or remote MTA.

If your mail server requires some form of authentication or transport layer encryption like SSL/TLS, you need to set up a local MTA that relays all outgoing email from the TeamDrive Host Server to your mail server using the appropriate protocol and credentials.

We recommend configuring a local Postfix instance to perform this duty. The following packages need to be installed:

```
[root@regserver ~]# dnf install postfix mailx cyrus-sasl-plain
```

The detailed configuration of the local Postfix instance depends heavily on your local environment and how the remote MTA accepts remote submissions and is out of the scope of this document.

See the Postfix SMTP client documentation at <http://www.postfix.org/smtp.8.html> for details on how to configure Postfix to use a relay server and make sure to test the correct operation by sending local emails using the `mail` command line utility and watching the Postfix log file `/var/log/maillog` for errors.

Once the Postfix service has been configured correctly, ensure that it will be started automatically upon system boot:

```
[root@regserver ~]# chkconfig postfix on
```

INSTALLING THE HOST SERVER COMPONENTS

6.1 Enable the TeamDrive Host Server `dnf` Repository

The TeamDrive Host Server components are available in the form of RPM packages, hosted in a dedicated `dnf` repository. This makes the installation and applying of future updates of the software very easy — you can simply run `dnf update` to keep your Host Server software up to date.

To enable the repository, you need to download the `td-hostserver.repo` file and place it into the directory `/etc/yum.repos.d/`, e.g. by using `wget`:

```
[root@hostserver ~]# wget -O /etc/yum.repos.d/td-hostserver.repo \
http://repo.teamdrive.net/td-hostserver.repo
```

This will enable the “TeamDrive Host Server Version 4.0” repository, which you can check by running `dnf repolist` afterwards:

```
[root@hostserver ~]# dnf repolist
Loaded plugins: security
repo id                repo name                status
td-hostserver-4.0     TeamDrive Host Server Version 4.0    2
base                  CentOS-8 - Base          6.367
extras                CentOS-8 - Extras        14
updates               CentOS-8 - Updates       1.094
repolist: 7.477
```

6.2 Download and Install the TeamDrive Host Server Package

Perform the download and installation of the Host Server installation RPM package using the `dnf` package manager:

```
dnf config-manager --set-disabled td-hostserver-3.0.013
dnf config-manager --set-disabled td-hostserver-3.5
dnf config-manager --set-disabled td-hostserver-3.6
dnf config-manager --set-disabled td-hostserver-3.7
dnf install td-hostserver
```

The TeamDrive Hosting Service depends on the Yvva Runtime Environment version 1.5.9 or later to be installed and configured. It will be installed by `dnf` as a dependency on `td-hostserver` automatically.

Once the TeamDrive Host Server software has been installed successfully, you can proceed with the initial configuration.

6.3 Installing the Host Server HTML Documentation (optional)

Beginning with Host Server version 3.0.013.10, the documentation (in HTML format) can be installed locally, so you can access it directly from the Host Server (or any other host running an Apache HTTP Server).

To install the HTML Documentation, install the following package via `dnf` from the “TeamDrive Host Server” repository:

```
[root@hostserver ~]# dnf install td-hostserver-doc-html
```

The HTML documents will be installed in directory `/var/www/html/td-hostserver-doc`. From your web browser, open the following URL to access the documentation:

<http://hostserver.yourdomain.com/td-hostserver-doc/>

Note: This step is optional. If you leave the documentation installed when the Host Server goes into production and is accessible from the public Internet, you should ensure to restrict access to this URL to trusted hosts or networks only. This can be achieved by adding the appropriate access control rules to the file `/etc/httpd/conf.d/td-hostserver-doc.httpd.conf`.

APACHE HTTP SERVER INSTALLATION AND CONFIGURATION

The Apache HTTP server and the `mod_ssl` Apache module should have already been installed as dependencies for the `td-hostserver` RPM package. You can verify this with the following command:

```
[root@hostserver ~]# dnf install httpd mod_ssl
  Package httpd-2.4.37-47.module_el8.6.0+1111+ce6f4ceb.1.x86_64 is already
↳ installed.
  Package mod_ssl-1:2.4.37-47.module_el8.6.0+1111+ce6f4ceb.1.x86_64 is already
↳ installed.
Dependencies resolved.
Nothing to do.
```

7.1 Update `httpd.conf`

Open the web server configuration file `/etc/httpd/conf/httpd.conf` in a text editor to change the following parameters:

```
KeepAlive On
KeepAliveTimeout 2
ServerName <Your ServerName>
```

For security reasons, we also advise to disable the so-called “Server Signature” - a feature that adds a line containing the server version and virtual host name to server-generated pages (e.g. internal error documents, FTP directory listings, etc):

```
ServerSignature Off
```

By default, the server version and operating system is also displayed in the `Server` response header field, e.g. `Server: Apache/2.2.15 (CentOS)`. To suppress this output, we suggest to update the `ServerTokens` option as follows:

```
ServerTokens Prod
```

7.2 Enable “Prefork” Mode

The `mod_ldap` module requires that apache run in prefork mode. Note that Apache will crash when running in a different mode.

To set the mode, execute:

```
sed -e '/LoadModule mpm_event_module/ s/^#*//' -i /etc/httpd/conf.modules.d/00-
↳ mpm.conf
sed -e '/#LoadModule mpm_prefork_module/ s/^#*//' -i /etc/httpd/conf.modules.d/00-
↳ mpm.conf
```

which will comment out the `mpm_event_module` and uncomment the `mpm_prefork_module`. The result should look:

```
# Select the MPM module which should be used by uncommenting exactly
# one of the following LoadModule lines. See the httpd.conf(5) man
# page for more information on changing the MPM.
...
LoadModule mpm_prefork_module modules/mod_mpm_prefork.so
...
#LoadModule mpm_worker_module modules/mod_mpm_worker.so
...
#LoadModule mpm_event_module modules/mod_mpm_event.so
```

7.3 Disable Unneeded Apache Modules

In the directory: `/etc/httpd/conf.modules.d` comment out all modules in the following config files. Using the linux stream editor (`sed`) with the following regular expression will add a '#' comment sign in each line starting with 'LoadModule':

```
sed -e '/LoadModule/ s/^#*/#/' -i /etc/httpd/conf.modules.d/00-dav.conf
sed -e '/LoadModule/ s/^#*/#/' -i /etc/httpd/conf.modules.d/00-lua.conf
sed -e '/LoadModule/ s/^#*/#/' -i /etc/httpd/conf.modules.d/00-proxy.conf
sed -e '/LoadModule/ s/^#*/#/' -i /etc/httpd/conf.modules.d/01-cgi.conf
sed -e '/LoadModule/ s/^#*/#/' -i /etc/httpd/conf.modules.d/10-proxy_h2.conf
```

Modify `/etc/httpd/conf.modules.d/00-base.conf` and leave only the following modules enabled by disabling all modules at first and enable only the required modules afterwards:

```
sed -e '/LoadModule/ s/^#*/#/' -i /etc/httpd/conf.modules.d/00-base.conf
sed -e '/#LoadModule alias_module/ s/^#*//' -i /etc/httpd/conf.modules.d/00-base.
↪conf
sed -e '/#LoadModule authz_core_module/ s/^#*//' -i /etc/httpd/conf.modules.d/00-
↪base.conf
sed -e '/#LoadModule autoindex_module/ s/^#*//' -i /etc/httpd/conf.modules.d/00-
↪base.conf
sed -e '/#LoadModule headers_module/ s/^#*//' -i /etc/httpd/conf.modules.d/00-base.
↪conf
sed -e '/#LoadModule log_config_module/ s/^#*//' -i /etc/httpd/conf.modules.d/00-
↪base.conf
sed -e '/#LoadModule mime_module/ s/^#*//' -i /etc/httpd/conf.modules.d/00-base.
↪conf
sed -e '/#LoadModule rewrite_module/ s/^#*//' -i /etc/httpd/conf.modules.d/00-base.
↪conf
sed -e '/#LoadModule setenvif_module/ s/^#*//' -i /etc/httpd/conf.modules.d/00-
↪base.conf
sed -e '/#LoadModule slotmem_shm_module/ s/^#*//' -i /etc/httpd/conf.modules.d/00-
↪base.conf
sed -e '/#LoadModule socache_shmcb_module/ s/^#*//' -i /etc/httpd/conf.modules.d/
↪00-base.conf
sed -e '/#LoadModule unixd_module/ s/^#*//' -i /etc/httpd/conf.modules.d/00-base.
↪conf
sed -e '/#LoadModule version_module/ s/^#*//' -i /etc/httpd/conf.modules.d/00-base.
↪conf
sed -e '/LoadModule/ s/^#*/#/' -i /etc/httpd/conf.modules.d/10-h2.conf
```

7.4 Disable access logs

The TeamDrive clients are polling the same url periodically for updates in the space. To prevent the same requests from overflowing the log file, the access logs should be deactivated:

```
sed -e '/ CustomLog/ s/^#*/ #/' -i /etc/httpd/conf/httpd.conf
sed -e '/TransferLog/ s/^#*/#/' -i /etc/httpd/conf.d/ssl.conf
sed -e '/CustomLog/ s/^#*/#/' -i /etc/httpd/conf.d/ssl.conf
```

7.5 Configure mod_ssl

The web-based TeamDrive Hosting Service Administration Console should be accessed via an encrypted SSL connection. To facilitate this, add the following to the end of the default <VirtualHost> section in /etc/httpd/conf.d/ssl.conf:

```
Include conf.d/td-hostserver.httpd.conf.ssl
</VirtualHost>
```

MYSQL INSTALLATION AND CONFIGURATION

8.1 Installing MySQL Server

The TeamDrive Hosting Service requires a MySQL database to store its information. This document assumes that the MySQL instance runs on the same host as the Host Server itself, connecting to it via the local socket file.

Alternatively, it's possible to use an external MySQL Server. In this case, you need to make sure that this external MySQL instance is reachable via TCP from the Host Server (usually via TCP port 3306) and that the `teamdrive` MySQL user account is defined correctly (e.g. the MySQL username in the remote database would become `teamdrive@hostserver.yourdomain.com` instead of `teamdrive@localhost`).

Most MySQL installations usually do not allow the `root` user to log in from a remote host. In this case the installation script is unable to create the dedicated `teamdrive` user automatically and you need to perform this step manually before performing the installation of the TeamDrive Hosting Service databases.

Especially the correct definition of the host part is critical, as MySQL considers `username@hostserver` and `username@hostserver.yourdomain.com` as two different user accounts.

Install the MySQL Client and Server packages from the default repository:

```
dnf install mysql mysql-server
```

For reliability and performance reasons, we recommend placing the MySQL data directory `/var/lib/mysql` on a dedicated file system or storage volume.

The default maximum file handle limit in CentOS 7/8 is 1024 which might be too less for the amount of file handles and database connections for the TeamDrive apache module. The amount of file handles can be calculated: tables (currently 26) x 2 (2 files per table) x apache processes x 2 (for restarting the apache). For less than 100 users it will be $26 \times 2 \times 20 \times 2 = 2080$ file handles, for 500 users $26 \times 2 \times 50 \times 2 = 2200$ file handles and for more than 1000 users $26 \times 150 \times 2 = 15600$

To be save, we increase the value to 65535 in the following three configuration files.

First: Edit `/etc/sysctl.conf` and add the below line, save and exit:

```
fs.file-max = 65535
```

Second: Increase the hard and soft limits in `/etc/security/limits.conf`. Add the below lines before the `#End`, save and exit:

```
* soft nproc 65535
* hard nproc 65535
* soft nofile 65535
* hard nofile 65535
```

After the change execute:

```
sysctl -p
```

Third: For MySQL, create an override file for the service:

```
mkdir -pv /etc/systemd/system/mysqld.service.d
echo "LimitNOFILE=65535" >> /etc/systemd/system/mysqld.service.d/override.conf
echo "LimitNPROC=65535" >> /etc/systemd/system/mysqld.service.d/override.conf
```

After the change execute:

```
systemctl daemon-reload
```

Start the MySQL server now:

```
[root@hostserver ~ ]# service mysqld start
Initializing MySQL database: Installing MySQL system tables...
OK
Filling help tables...
OK

To start mysqld at boot time you have to copy
support-files/mysql.server to the right place for your system

PLEASE REMEMBER TO SET A PASSWORD FOR THE MySQL root USER !
To do so, start the server, then issue the following commands:

/usr/bin/mysqladmin -u root password 'new-password'
/usr/bin/mysqladmin -u root -h hostinstalltest.local password 'new-password'

Alternatively you can run:
/usr/bin/mysql_secure_installation

which will also give you the option of removing the test
databases and anonymous user created by default. This is
strongly recommended for production servers.

See the manual for more instructions.

You can start the MySQL daemon with:
cd /usr ; /usr/bin/mysqld_safe &

You can test the MySQL daemon with mysql-test-run.pl
cd /usr/mysql-test ; perl mysql-test-run.pl

Please report any problems with the /usr/bin/mysqlbug script!

Starting mysqld: [ OK ]
```

Run the secure installation script and follow the recommendations. Make sure to create a password for the MySQL root user and take note of it:

```
[root@hostserver ~ ]# mysql_secure_installation

Securing the MySQL server deployment.

Connecting to MySQL using a blank password.

VALIDATE PASSWORD COMPONENT can be used to test passwords
and improve security. It checks the strength of password
and allows the users to set only those passwords which are
secure enough. Would you like to setup VALIDATE PASSWORD component?

Press y|Y for Yes, any other key for No: No
Please set the password for root here.
```

```

New password: <mysql_root_pw>

Re-enter new password: <mysql_root_pw>
By default, a MySQL installation has an anonymous user,
allowing anyone to log into MySQL without having to have
a user account created for them. This is intended only for
testing, and to make the installation go a bit smoother.
You should remove them before moving into a production
environment.

Remove anonymous users? (Press y|Y for Yes, any other key for No) : Y
Success.

Normally, root should only be allowed to connect from
'localhost'. This ensures that someone cannot guess at
the root password from the network.

Disallow root login remotely? (Press y|Y for Yes, any other key for No) : Y
Success.

By default, MySQL comes with a database named 'test' that
anyone can access. This is also intended only for testing,
and should be removed before moving into a production
environment.

Remove test database and access to it? (Press y|Y for Yes, any other key for
↪No) : Y
- Dropping test database...
Success.

- Removing privileges on test database...
Success.

Reloading the privilege tables will ensure that all changes
made so far will take effect immediately.

Reload privilege tables now? (Press y|Y for Yes, any other key for No) : Y
Success.

All done!

```

MySQL is now up and running and you can proceed with creating the `teamdrive` user and the MySQL databases required for the TeamDrive Host Server.

8.2 Creating TeamDrive MySQL User and Databases

The TeamDrive Hosting Service requires two MySQL databases `hostapilog` and `pSPACE`, which will be accessed using a dedicated `teamdrive` MySQL user.

The Host Server installation package ships with a script that performs the required configuration steps:

- Modify the local configuration file `/etc/my.cnf`, start and enable MySQL Server at system bootup (only when using a local MySQL Server)
- Create the MySQL user account `teamdrive`, assign the provided password and assign the necessary database privileges (requires access to the MySQL `root` account)
- Create and populate the required Hosting Service MySQL databases
- Modify the local Host Server configuration file `/etc/td-hostserver.my.cnf`

The following example assumes that the MySQL database is located on the same system where the TeamDrive Host Server instance is installed.

You need to have the following information available:

- The password of the MySQL root user account you defined while running `mysql_secure_installation`
- The password that you want to assign to the `teamdrive` user

The script is part of the `td-hostserver` package and is installed in `/opt/teamdrive/hostserver/mysql/mysql_install.sh`. Call it as the root user and follow the instructions:

```
[root@hostserver ~]# /opt/teamdrive/hostserver/mysql/mysql_install.sh

TeamDrive Hosting Service MySQL Database Install Script
-----

Configuring MySQL database for TeamDrive Hosting Service
version 3.5.x.0

This script will perform the following steps:

- Modify the local configuration file /etc/my.cnf,
  start and enable MySQL Server
  (only when MySQL Server runs locally)
- Create the required MySQL user "teamdrive",
  assign the provided password and the required
  database privileges
  (requires access to the MySQL root account)
- Create and populate the required Hosting Service
  MySQL databases
- Modify the local Host Server configuration file
  /etc/td-hostserver.my.cnf

Enter MySQL hostname: localhost
Enter MySQL root password for localhost: <mysql_root_pw>
Enter MySQL password to be set for user teamdrive: <td_pw>

mysqld (pid 7490) is running...
Stopping mysqld: [ OK ]
Changing local MySQL Server configuration...
Backing up existing configuration file /etc/my.cnf...
`/etc/my.cnf' -> `/etc/my.cnf-2015-05-19-17:19.bak'
Starting and enabling MySQL Server...
Starting mysqld: [ OK ]
Trying to connect to the MySQL server as root...
+-----+
| MySQL Version |
+-----+
| 5.1.73        |
+-----+
Creating teamdrive MySQL user on localhost
Trying to connect to the MySQL server as the teamdrive user...
Creating Hosting Service databases...
Updating /etc/td-hostserver.my.cnf...
Backing up existing configuration file ...
`/etc/td-hostserver.my.cnf' -> `/etc/td-hostserver.my.cnf-2015-05-19-17:19.bak'

Finished!
The MySQL configuration for TeamDrive Hosting Service
version 3.5.x.0 is now complete.
```

The MySQL database is now properly configured and populated. As a final test, try logging into the MySQL database from the Host Server system, using the `teamdrive` user account and the password you defined — you should be able to see and access the TeamDrive Hosting Service databases:

```
[root@hostserver ~]# mysql -u teamdrive -p<password>
Welcome to the MySQL monitor.  Commands end with ; or \g.
Your MySQL connection id is 51
Server version: 5.1.71 Source distribution

Copyright (c) 2000, 2013, Oracle and/or its affiliates. All rights reserved.

Oracle is a registered trademark of Oracle Corporation and/or its
affiliates. Other names may be trademarks of their respective
owners.

Type 'help;' or '\h' for help. Type '\c' to clear the current input statement.

mysql> SHOW DATABASES;
+-----+
| Database |
+-----+
| information_schema |
| hostapilog |
| pspace |
+-----+
3 rows in set (0.00 sec)

mysql> QUIT
Bye
```

8.3 CentOS Hardening

We recommend to harden the CentOS system as described in *TeamDrive Server Hardening* (page 31).

The script can be retrieved from TeamDrive Systems.

TEAMDRIVE SERVER HARDENING

The server hardening is based on the the CIS Benchmark for CentOS 8 version 2.0.0 which can be downloaded from the Center for Internet Security:

<https://www.cisecurity.org/cis-benchmarks/>

9.1 CentOS 8 Partition Layout

Partition Layout:

```
- root          42.0 GB
|              11.0 GB
|- dev         1.9 GB (tmpfs, noexec, nosuid, nodev)
|  |- shm     2.0 GB (tmpfs, noexec, nosuid, nodev)
|- run        2.0 GB (noexec, nosuid, nodev)
|- sys
|  |- fs
|     |- cgroup 2.0 GB (tmpfs)
|- usr        4.7 GB (nodev)
|- boot       471 MB (noexec, nosuid, nodev)
|- opt        950 MB (nosuid, nodev)
|- proc                          (noexec, nosuid, nodev, hidepid=2*)
|- home       471 MB (noexec, nosuid, nodev)
|- tmp        950 MB (tmpfs, noexec, nosuid, nodev)
|- var
|  |- www     471 MB (noexec, nosuid, nodev)
|  |- ossec   950 MB (nosuid, nodev)
|  |- spool   471 MB (noexec, nosuid, nodev)
|  |- tmp     950 MB (noexec, nosuid, nodev)
|  |- log     4.7 GB (noexec, nosuid, nodev)
|     |- audit 9.4 GB (noexec, nosuid, nodev)
|- run                          (tmpfs, noexec, nosuid, nodev)
|  |- user
|     |- 0     393 MB (tmpfs)
|- swap                          (encrypted)
```

(*) meaning all pids hidden for all users

9.2 Service Isolation and Sandboxing

The following services are sandboxed using a 01-sandboxing.conf addin to restrict access to file systems, networks, devices, kernel capabilities and system calls:

- aide: Advanced Intrusion Detection Environment
- auditd: Linux Auditing System (see /etc/audit/rules.d/ for audit rules)

- chkrootkit: Chkrootkit Security Scanner
- chronyd: Network Time Protocol (see `/etc/chrony.conf` for list of time servers)
- crond: Cronjob
- dbus: inter-process communication
- dnf-automatic-install: synchronizes package metadata
- dnscrypt-proxy: DNS proxy using encrypted DNS
- dnsmasq: DNS-Server
- fail2ban: Fail2ban scans log files and bans IPs that show the malicious signs like too many password failures, seeking for exploits, etc.
- firewalld: Firewall
- haveged: random number generator
- httpd: Apache webserver
- irqbalance: Linux daemon that distributes interrupts over among the processors and cores in your computer system
- mysqld: MySQL database server
- NetworkManager: Program for providing detection and configuration for systems to automatically connect to networks
- php-fpm: Execution of PHP scripts
- polkit: application-level toolkit for defining and handling the policy that allows unprivileged processes to speak to privileged processes
- postfix: mail transport agent
- rkhunter: rootkit scanner
- rsyslog: log processing
- s3d: TeamDrive S3-Daemon (only used on the hosting server)
- sshd: SSH Deamon
- systemd-logind: System service that manages user logins
- systemd-udev: kernel events processing
- td-hostserver: TeamDrive Hosting Server background task (only used on the hosting server)
- td-regserver: TeamDrive Registration Server background task (only used on the registration server)
- td-webportal: TeamDrive Webportal Server background task (only used on the webportal server)
- tmp.mount: mounting temporary filesystem
- usbguard: USB device watcher

9.3 SSH Authentication, Login and Passwords

- SSL: Disabled TLS 0.9, SSL 3.0, TLS 1.0, TLS 1.1 (see `/etc/crypto-policies/back-ends/gnutls.config`)
- Bootloader: see `/etc/default/grub`
- SSH Banner: see `/etc/issue`
- SSH Login on port 2021 instead of 22: Several adjustments in `/etc/ssh/sshd_config`

- Login parameters in /etc/login.defs: password expiry after 60 days (PASS_MAX_DAYS), set login retries to 5 (LOGIN_RETRIES) with lockouts for failed password attempts, default UMASK set to 022 (/etc/profile, /etc/init.d/functions, /etc/bashrc, /etc/csh.cshrc)
- Password quality, length (min 18 characters, set in /etc/security/pwquality.conf), hashing algorithm, reuse prevention
- OpenSSH Client and Server configured compliant to:

```

- DISA STIG for Red Hat Enterprise Linux 8 V1R7
- CIS Red Hat Enterprise Linux 8 Benchmark for Level 1 - Server
- CIS Red Hat Enterprise Linux 8 Benchmark for Level 2 - Server
- PCI-DSS v3.2.1 Control Baseline for Red Hat Enterprise Linux 8
- Protection Profile for General Purpose Operating Systems (Red Hat Enterprise_
↳Linux 8)
- Australian Cyber Security Centre (ACSC) ISM Official (Red Hat Enterprise_
↳Linux 8)
- Health Insurance Portability and Accountability Act (HIPAA) for Red Hat_
↳Enterprise Linux 8
    
```

9.4 Kernel adjustments

- Kernel self-protection and exploit mitigation (settings l1tf="full,force", mds="full,nosmt", nosmt="force", spectre_v2="on", spectre_v2_user="on", spec_store_bypass_disable="on", kvm.nx_huge_pages="force", tsx="off", tsx_async_abort="full,nosmt")
- Restricting access to kernel pointers in the proc filesystem by hiding kernel symbol addresses regardless of privileges
- Disabling of entire ptrace, core dumps (see /etc/sysctl.d/50-coredump.conf, /etc/systemd/coredump.conf) and debugging functionality including debugfs (setting slub_debug=FZ)
- Disabled kexec and kernel module loading
- ASLR with high entropy
- Protected symlinks, hardlinks, fifos and regular files to mitigate TOCTOU (Time-of-check to time-of-use) race conditions and data spoofing attacks
- Prevent use-after-free attacks through poisoning, sanity checks and red zoning of SLUB/SLAB objects
- Randomize kernel stack offset on syscall entry (setting randomize_kstack_offset=on)
- Disabled slab merging, which significantly increases the difficulty of heap exploitation by preventing overwriting objects from merged caches and by making it harder to influence slab cache layout (settings slab_nomerge="", pti="on", vsyscall="none", debugfs="off", oops="panic")
- Mitigate use-after-free vulnerabilities and erase sensitive information in memory by zeroing of memory during allocation and free time (setting init_on_alloc=1, init_on_free=1)
- Randomization of page allocator freelists and the kernel stack offset on each syscal (setting page_alloc.shuffle=1)
- Kernel Page Table Isolation to mitigate Meltdown and prevention of KASLR bypasses
- Disabled vsyscalls to protect against ROP attacks
- Enabling kernel panic mode upon oops to prevent continued operation with compromised reliability
- CPU vulnerability mitigations
- Fully enabled hardening of JIT-compiled BPF to mitigate some types of JIT spraying attacks

9.5 Filesystem

- Adjusted mount options in `/etc/fstab`
- Encrypted swap device
- Disabled uncommon filesystems

9.6 Network

- Entire IPv6 stack disabled
- IPv4 stack hardening:
 - Protection against SYN flood attacks
 - Protection against time-wait assassination by dropping RST packets for sockets in the time-wait state
 - Protection against IP spoofing through strict mode reverse path filtering
 - Protection against Smurf attacks
 - Prevent clock fingerprinting through ICMP timestamps
 - Prevent man-in-the-middle attacks and minimise information disclosure by disabling ICMP redirect acceptance, sending and echo and also disabling source routing
 - Prevent exploits by disabling TCP SACK
 - Logging of martian packets
 - TCP ISN CPU Information Leak Protection by using the `tirdad` kernel module
 - Disabled uncommon network protocols and (obsolete) services and wireless networking

9.7 Firewall

- Using `systemd` sandboxed `firewalld` with `nftables` backend and “drop” as default zone
- Incoming traffic allowed for: 2021 (SSH), 80 (HTTP) 443 (HTTPS)

9.8 Shell

- Deinstalled unused shells: `tcsh`, `csh`, `ash`, `ksh`, `zsh`, `es`, `rc`, `esh`, `dash`, `screen`
- Default shell: `tmux` with `auto-logoff` (see `/etc/tmux.conf`, `/etc/profile.d/timeout.sh`) (`tmux` hint: Copy & Paste using mouse by pressing `shift-key`)

9.9 Disabled services

Ensured that unused services are disabled:

- `autofs`
- `avahi-daemon`
- `bind9`
- `bluetooth`
- `chargen-dgram`

- chargin-stream
- chrony-wait
- cups
- cups-browsed
- daytime-dgram
- daytime-stream
- dhcpd
- discard-dgram
- discard-strea
- dovecot
- echo-dgram
- echo-stream
- hidd
- irqbalance
- isc-dhcp-server
- isc-dhcp-server6
- kdump
- lpd.service
- named
- nfs
- nfs-server
- nfslock
- nginx
- nis
- nmb
- ntalk
- ntpd
- ntpdate
- portmap
- proftpd
- pure-ftpd
- rexec.socket.service
- rhnsd
- rlogin.socket.service
- rngd
- rpcbind.service
- rpcbind.socket
- rpcgssd
- rpcidmapd

- rpsvcgssd
- rsh.socket.service
- rsyncd
- samba-ad-dc
- sendmail
- slapd
- smb
- snmpd
- sntp
- squid
- systemd-timesyncd
- tcpmux-server
- telnet.socket.service
- tftp.socket
- time-dgram
- time-stream
- vsftpd
- vsftpd
- xinetd
- ypserv
- systemd-coredump.service
- plymouth-halt.service
- plymouth-poweroff.service
- plymouth-quit-wait.service
- plymouth-reboot.service
- plymouth-switch-root.service
- plymouth-kexec.service
- plymouth-quit.service
- plymouth-read-write.service
- plymouth-start.service

9.10 Package Management and Automatic (Security) Updates

- Enabled gpg check for all repositories and for local packages
- Using `dnf-automatic` and `needrestart` for update notification/installation and restart of services, see `/etc/dnf/automatic.conf`

9.11 Virus check

ClamAV for Linux (see <https://www.clamav.net>) is installed on the server. The ClamAV service needs 1 GB RAM and will use 1 full CPU core during the scan process. See `/etc/clamd.d/scan.conf` for scan configuration and parameters.

Signature databases from ClamAV and additional 3rd party signature databases via clamav-unofficial-sigs <https://github.com/extremeshok/clamav-unofficial-sigs>

9.12 Rootkit Scanner

Two rootkit scanner are installed `chkrootkit` with daily scan interval:

<http://www.chkrootkit.org>

and `rkhunter` with daily scan interval including the forensic unhide module to detect hidden processes and TCP/UDP ports:

<https://rkhunter.sourceforge.net>

9.13 RNG and Entropy

- RDRAND distrusted by the kernel as an entropy source
- Using systemd sandboxed haveged (HAVEGE algorithm) as random number generator daemon for high entropy <https://github.com/jirka-h/haveged>

9.14 Fail2Ban

Fail2ban (see <https://www.fail2ban.org>) scans log files (e.g. `/var/log/apache/error_log`) and bans IPs that show the malicious signs – too many password failures, seeking for exploits, etc. Generally Fail2Ban is then used to update firewall rules to reject the IP addresses for a specified amount of time, although any arbitrary other action (e.g. sending an email) could also be configured. Out of the box Fail2Ban comes with filters for various services (apache, courier, ssh, etc).

Whitelist your own IPs in: `/etc/fail2ban/jail.local`

Fail2ban is activated for Apache, PHP, postfix and SSH with these jails: `apache-auth`, `apache-badbots`, `apache-noscript`, `apache-overflows`, `apache-shellshock`, `php-url-fopen`

To check currently banned IPs:

```
fail2ban-client banned
```

9.15 fapolicyd

Setting and enforcing a policy that either allows or denies application execution based on a rule set efficiently prevents the execution of unknown and potentially malicious software.

Software installed using `dnf` will be automatically whitelisted.

In case of installing own scripts, you have to whitelist them, see:

```
https://access.redhat.com/documentation/de-de/red\_hat\_enterprise\_linux/8/html/
↪security\_hardening/assembly\_blocking-and-allowing-applications-using-fapolicyd\_
↪security-hardening#marking-files-as-trusted-using-an-additional-source-of-trust\_
↪assembly\_blocking-and-allowing-applications-using-fapolicyd
```

9.16 Intrusion Detection (IDS/File Integrity)

Daily AIDE scan and check <https://aide.github.io/>

The fapolicyd software framework controls the execution of applications based on a user-defined policy. This is one of the most efficient ways to prevent running untrusted and possibly malicious applications on the system (“restrictive” policy rule set defined in `/etc/fapolicyd/rules.d/*`).

More informations:

https://access.redhat.com/documentation/en-us/red_hat_enterprise_linux/8/html/security_hardening/assembly_blocking-and-allowing-applications-using-fapolicyd_security-hardening

9.17 DNSCrypt

DNSCrypt with DNSSEC using systemd sandboxed dnscrypt-proxy and dnsmasq as local DNS caching server.

DNSCrypt is a protocol that authenticates communications between a DNS client and a DNS resolver. It prevents DNS spoofing. It uses cryptographic signatures to verify that responses originate from the chosen DNS resolver and haven't been tampered with.

Related conf-Files:

```
- /etc/NetworkManager/NetworkManager.conf --> dns=none
- /etc/resolv.conf --> nameserver 127.0.0.1
- /etc/systemd/resolved.conf --> DNSStubListener=no
- /etc/dnscrypt-proxy/dnscrypt-proxy.toml
```

The DNSCrypt will load and use a DNS server from this list:

<https://dnscrypt.info/public-servers>

In case you have to use your own DNS server, remove the immutable flag from:

```
chattr -i /etc/resolv.conf
```

and change the nameserver in `/etc/resolv.conf` to your own value.

9.18 NTP

Secure NTP with NTS (Network Time Security, RFC 8915) via systemd sandboxed chronyd

9.19 Accounting and Auditing

Using comprehensive auditing rules compliant to:

- DISA STIG for Red Hat Enterprise Linux 8 V1R7
- CIS Red Hat Enterprise Linux 8 Benchmark for Level 2 - Server
- PCI-DSS v3.2.1 Control Baseline for Red Hat Enterprise Linux 8
- Protection Profile for General Purpose Operating Systems (Red Hat Enterprise Linux 8)
- Australian Cyber Security Centre (ACSC) ISM Official (Red Hat Enterprise Linux 8)
- Health Insurance Portability and Accountability Act (HIPAA) for Red Hat Enterprise Linux 8

9.20 PHP (only Registration Server)

- Using OWASP recommended security configuration
- Using systemd sandboxed FastCGI Process Manager (FPM)

9.21 CentOS Hardening Check

To check the hardening score, use the Lynis - Security auditing tool and ossec benchmark. Start both checks with:

```
/root/hardening/benchmark.sh
```

Lynis generates a test result after 5 minutes analyzing the system with a green, yellow and red status and calculates a hardening index which should be 97 of 100.

After the Lynis check, the OpenSCAP scanner will be started directly:

<https://www.open-scap.org>

The OpenSCAP scanner executes the following 8 CIS checks which takes about 25 minutes in total (an overview and further descriptions of the test can be found here <https://www.mankier.com/8/scap-security-guide>):

```
- CIS Red Hat Enterprise Linux 8 Benchmark for Level 1 - Server
- CIS Red Hat Enterprise Linux 8 Benchmark for Level 2 - Server
- PCI-DSS v3.2.1 Control Baseline for Red Hat Enterprise Linux 8
- ANSSI-BP-028 (enhanced)
- Health Insurance Portability and Accountability Act (HIPAA)
- Australian Cyber Security Centre (ACSC) ISM Official
- Protection Profile for General Purpose Operating Systems
- DISA STIG for Red Hat Enterprise Linux 8
```

Each check will generate a html result file located in:

```
/root/hardening/
```

9.22 Known problems caused by the hardening

An dnf update might fail in case of updating the “setup”-package. To fix the problem:

```
chattr -i /etc/shells
dnf update
chattr +i /etc/shells
```

If dnf update fails with “glibc-devel-2.28-225.el8.i686 has inferior architecture” use:

```
dnf update --allowdowngrading
```

PRE-INSTALLATION TASKS

10.1 Mount the Space Storage Volume

The toplevel directory `/spacedata` contains the mount points for all space volumes. By default, the mount point `vol01` has already been created by the `td-hostserver` RPM package. Note that it must be owned by the user that the Apache HTTP Server runs under (usually `apache`).

You need to create a dedicated file system that provides the requirements outlined in chapter storage-requirements.

Mount the file system and create the respective mount entry in `/etc/fstab` to enable automatic mounting of the file system at bootup. Please consult your Operating System documentation for details on how to perform this step.

Warning: The space volume's file system **must** be mounted to `/spacedata/vol01`, not `/spacedata`, to make it possible to mount additional volumes underneath the `/spacedata` directory, if required.

10.1.1 Verifying File Locking

The Space Storage Volume must provide reliable file locking. This is not always the case with certain network mounted (NFS) volumes, which should be verified before usage.

TDLogTest is a tool which simulates the concurrent access and locking patterns generated by multiple TeamDrive Clients. This tool can be used to test whether file locking support is compatible with the TeamDrive Hosting Service.

Note: The test cannot confirm with 100% certainty, whether an NFS volume is compatible with TeamDrive. However, failure of the test indicates that a volume is unfit to serve as `/spacedata` on a Host Server.

The following is a step-by-step guide to running TDLogTest:

1. Download the package from:

```
http://s3download.teamdrive.net/HostServer/TDLogTest-1485.tar.gz
```

and copy it to the Host Server machine.

2. Create a test directory on the Space Volume, for example:

```
mkdir /spacedata/vol01/TDLogTest
```

3. Enter this directory and extract the content of the tar archive, for example:

```
tar zxvf ~/TDLogTest-1485.tar.gz
```

4. Edit `TDLogTest.cfg`, set the path in `TDLOGS` to the directory to be used for testing.

5. Initialize the test directory by running:

```
./initTDLogTest
```

6. Start the test by running:

```
./startTDLogTest
```

The script spawns a (definable) number of reader and writer background processes which log their progress to `STDOUT`. Errors will be logged to `TDLogTest.err` by default. To stop the test, call `./stopTDLogTest`.

Keep the test running for a while. Try using different values for readers and writers as well, by stopping the test and passing different options to `startTDLogTest`. Also try creating multiple test directories and spawning more readers/writers using a different location.

If there are multiple Host Server instances connected to the same NFS volume then the test must be performed from multiple instances simultaneously, after the initial test with one instance succeeded.

10.2 Replacing the self-signed SSL certificates with proper certificates

The default Apache HTTP Server installation ships with self-signed SSL certificates for testing purposes. We strongly recommend to purchase and install proper SSL certificates and keys before moving the server into production.

You will need a properly signed SSL certificate (+ key) and an intermediate certificate (certificate chain) from a trusted authority.

Edit `/etc/httpd/conf.d/ssl.conf` and enter the absolute location of your files into the appropriate settings:

```
SSLCertificateFile /path/to/your_domain.crt
SSLCertificateKeyFile /path/to/your_domain.key
```

Depending on your certificate provider and your security needs, you probably want to set:

```
SSLCertificateChainFile /path/to/server-chain.crt
```

or:

```
SSLCACertificateFile /path/to/gd_bundle.crt
```

After saving the changes, restart your `httpd` and watch out for errors:

```
[root@localhost ~]# service httpd restart
```

Now you can logout and proceed with the configuration via browser to register the Web Portal as described in “Associating the Web Portal with a Provider” section in the web portal documentation. For production use please read the following two chapters about the necessary storage.

10.3 Starting the Host Server Instance

After all configuration steps have been performed, we can start the TeamDrive Services to conclude the initial installation/configuration.

10.3.1 Starting td-hostserver

To activate the `yvvd`-based `td-hostserver` background task you have to start the service using the provided init script.

The configuration file `/etc/td-hosting.conf` defines how this process is run. You usually don't have to modify these settings.

To start the `td-hostserver` program, use the `service` command as user root:

```
[root@hostserver ~]# service td-hostserver start
Starting TeamDrive Hosting Services: [ OK ]
```

Use the `status` option to the `service` command to verify that the service has started:

```
[root@hostserver ~]# service td-hostserver status
yvvad (pid 2506) is running...
```

If `td-hostserver` does not start (process `yvvad` is not running), check the log file `/var/log/td-hostserver.log` for errors. See chapter Troubleshooting for details.

10.3.2 Starting the Apache HTTP Server

Now the Apache HTTP Server can be started, which provides the TeamDrive Host Server functionality (via `mod_ospace`) as well as access to the TeamDrive Hosting Service Administration Console and API (via `mod_yvva`).

You can start the service manually using the following command:

```
[root@hostserver ~]# service httpd start
```

Warning: At this point, the Host Server's web server is answering incoming requests from any web client that can connect to its address. For security purposes, you should not make it accessible from the public Internet until you have concluded the initial configuration, e.g. by blocking external accesses using a firewall.

Check the log file `/var/log/httpd/error_log`, `/var/log/td-hostserver.log`, and `/var/log/mod_ospace.log` for startup messages and possible errors:

```
[notice] mod_yvva 1.4.1 (Jan 10 2017 11:57:45) loaded
[notice] Logging (=error) to: /var/log/td-hostserver.log
[notice] Apache/2.2.31 (Unix) mod_ssl/2.2.31 OpenSSL/1.0.1k-fips configured
-- resuming normal operations
[notice] mod_ospace 1.7.10 Loaded; Build Nov 17 2016 16:55:00;
Crash-Reporting-Disabled
```

Please consult chapter troubleshooting if there is an error when starting the service.

Note: You may observe Admin API Errors like the following one:

```
Admin API, Error loading parameters: Host Server setup has not been completed
```

These errors can be ignored at this stage. They are caused by the fact that the Host Server has not been configured and registered with a Registration Server yet. This step will be described in the following chapter.

INITIAL HOST SERVER CONFIGURATION

11.1 Registering and Activating the Host Server

From a desktop system that can connect to the Host Server via HTTPS, start a web browser like Mozilla Firefox, Google Chrome (or any other modern web browser) and start the configuration process by opening the following URL in your browser:

`https://hostserver.yourdomain.com/admin/`

This should open the Host Server Setup page. If you get an error message like “500 Internal Server Error”, check the log files for any errors. See chapter web installation 500 internal server error for details.

Note: If you haven’t replaced the server’s self-signed default SSL certificate yet, your web browser most likely will complain about an untrusted/insecure connection. Either replace the SSL certificate with an appropriate one before you proceed, or ignore this message.

Alternatively, you can access the Setup Page via an unencrypted HTTP connection. In this case, you will be prompted to proceed using an insecure connection.

When everything is configured correctly, you will see the TeamDrive Host Server Setup page that will guide you through the initial configuration:

Fill out the fields according to your environment and requirements:

Admin Username The name of the user account with full administrative privileges.

Admin Password The administrator password that you need to provide to login to the Host Server Administration Console.

Admin Email The email address of the Administrator. This field is optional. This email address is used for 2-factor authentication (if enabled).

Host Server Domain Name The domain name of this Host Server. This is the domain name that TeamDrive clients will use to create and access Spaces. The setup tool will try to determine and fill in this name automatically, please ensure that it is a fully-qualified and resolvable domain name (the setup will try to connect the server using the domain name; if your network configuration doesn’t allow, that an outgoing request will go back to the server, try to add the domain name to the `/etc/hosts` file).

Note: Dont use an **IP address** instead of a domain name, because using an IP address will cause the following problems: Register a SSL certificate for an IP address can be a problem and the TeamDrive client applications on the Apple platform (MAC and IOS) require a valid and official SSL certificate for the HTTPS communication. Apple only allows HTTPS connections. The second problem is, that the IP of the server cant be changed anymore. There is no possibility in the TeamDrive clients to change the space URL later on. If the server will be not longer reachable by the initial name any more, all Spaces are lost and cant be synchronized any more.

Provider Code The Host Server will be assigned to a Provider on the specified Registration Server. The Provider Code (aka Distributor Code) is a 4 character code, consisting of letters A-Z and 0-9. **If you don’t have**

Fig. 11.1: Host Server Setup Page

a **Provider Code** yet, please contact **TeamDrive Systems** for obtaining you individual **Provider Code**. This code can not be changed later on.

Host Server API IP Whitelist Enter a comma separated list of IP addresses of systems that are permitted to access the Host Server API. **This list must include the IP address of the Registration Server’s Admin Console. Please contact TeamDrive Systems for the correct value if you don’t manage your own Registration Server.**

Reg. Server Domain Name Enter the fully qualified domain name of the Registration Server. Setup will ping this domain to ensure that the Registration Server is running and reachable. **Please contact TeamDrive Systems for the correct value if you don’t manage your own Registration Server.**

Registration Server Name All Host Servers must be registered with a Registration Server. Enter the name of your Registration Server here. **Please contact TeamDrive Systems for the correct value if you don’t manage your own Registration Server.**

Reg. Server API Salt The API Salt is a code that allows the Host Server to validate calls to the Host Server’s API. This value must match the value of the `APIChecksumSalt` setting on the Registration Server to avoid “man in the middle”-attacks. Please consult the Registration Server Documentation on how to obtain it or contact TeamDrive Systems for the correct value if you don’t manage your own registration server.

After you have entered all the required details, click **Setup** to initiate the Host Server configuration and registration process with the Registration Server. After performing some initial checks, the setup process will summarize the information that it will use to perform the registration with the selected Registration Server.

Click **Register Server** to proceed with the registration, **Reset** to abort and return to the setup page.

Warning: If you need to restart the Registration/Activation process because of incorrectly entered values, it’s absolutely necessary to restart the Apache HTTP Server to roll back some internal changes:

```
[root@hostserver ~]# service httpd restart
```

hostsrv35.local

TEAMDRIVE

TeamDrive Hosting
Registration

Verify the settings below, and then click Register Server to register this Host Server with the specified Registration Server.

If any of the settings are incorrect, click Reset to clear the database and restart the setup process.
NOTE: Restart of Apache is required after Reset.

Registration Server Name: _____
Reg. Server Domain Name: _____
Provider Code: _____

Reset Register Server

Fig. 11.2: Host Server Registration Confirmation

Communication within the TeamDrive network is encrypted with a public-private encryption key pair. During registration, this key pair is generated by the Host Server and the public key is sent to the Registration Server. This will result in the creation of a new user account on the Registration Server, named `tdhosting.<host domain name>`, e.g. `tdhosting.hostserver.yourdomain.com`, and a device and license associated with that user.

Before the Host Server registration can be concluded, you are required to enter an Activation Code. For security reasons, you will not receive this code automatically. If you don't run your own Registration Server, you need to request this code from your Registration Server operator (usually TeamDrive Systems).

The activation code can be obtained from the Registration Server's Administration Console in **Server Management -> Manage Servers** page.

Take note of this activation code, enter it into the Host Server's activation page and click **Activate server**.

11.2 Setup and Administration

Upon successful activation, you will be presented with the Host Server's Administration Console Login Screen.

Enter the username and password you defined during the initial setup to log in.

Upon successful login, you will see the Host Server's Administration Console Home Screen.

At this point, you have concluded the Host Server's basic configuration and registration. See the *TeamDrive Host Server Administration Guide* for more details on how to use the Administration Console and how to accomplish other configuration tasks.

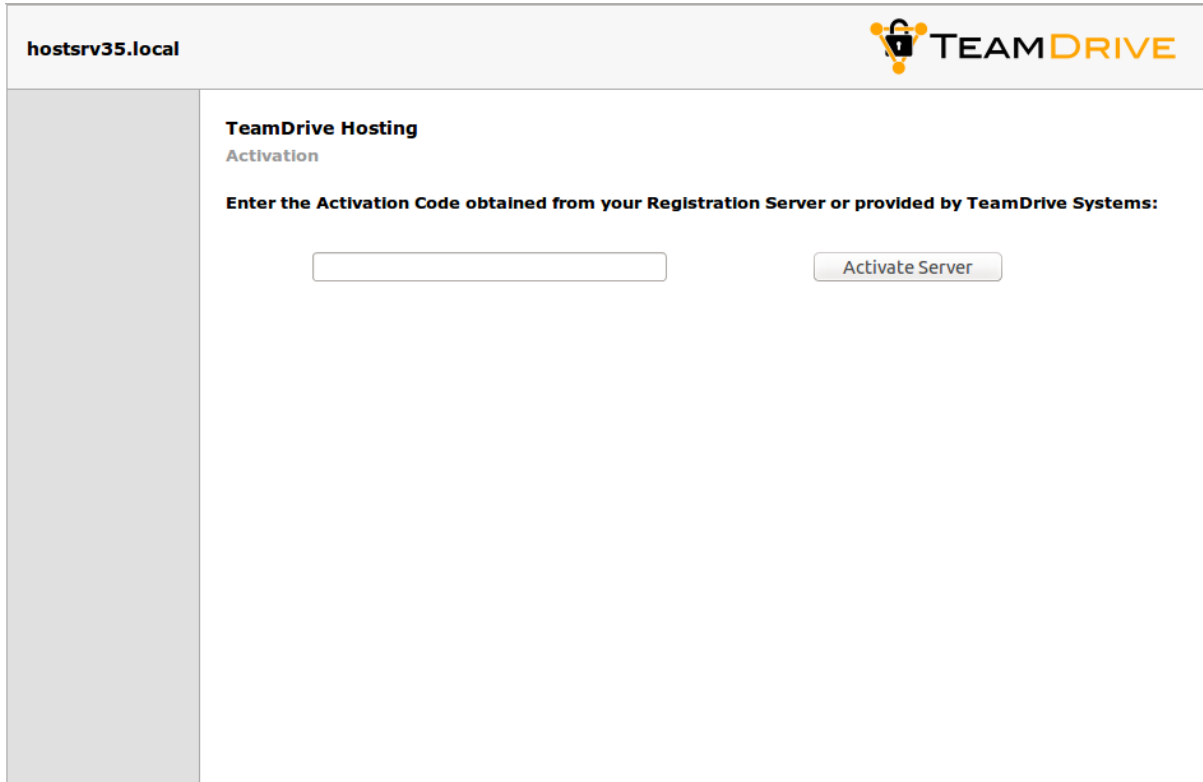

Fig. 11.3: Host Server Activation Window

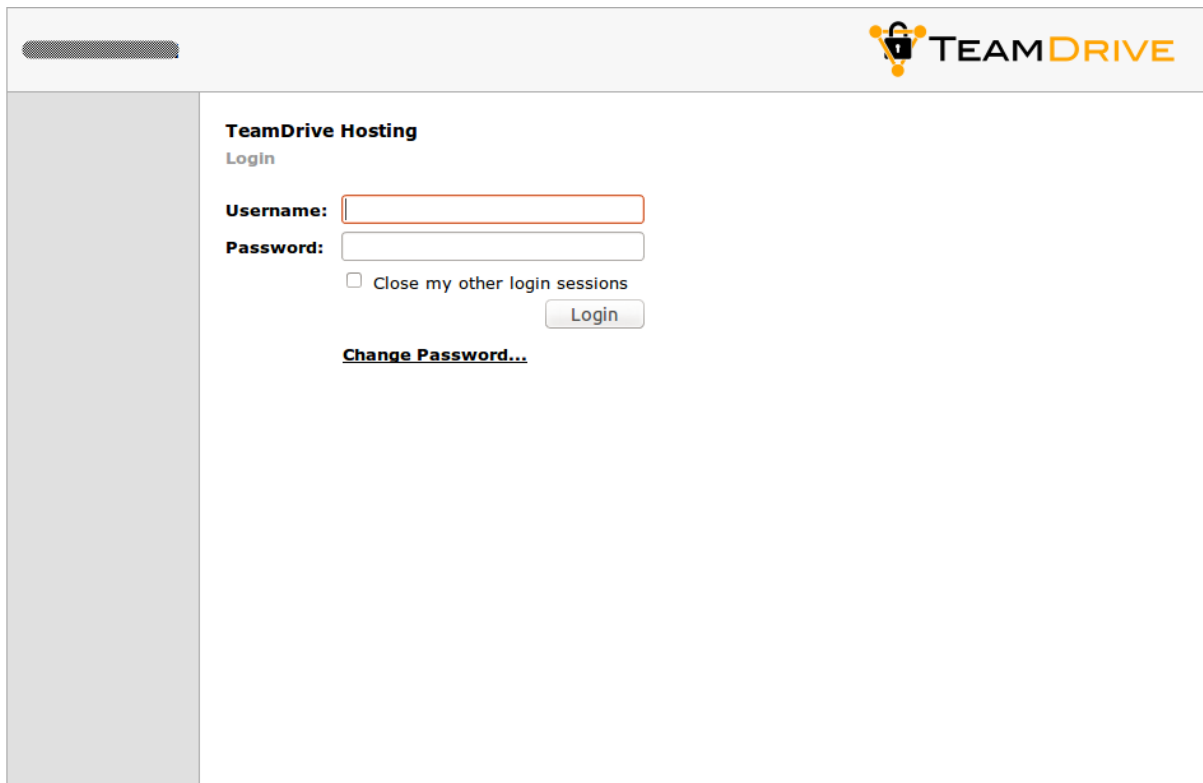

Fig. 11.4: Host Server Admin Console: Login Screen

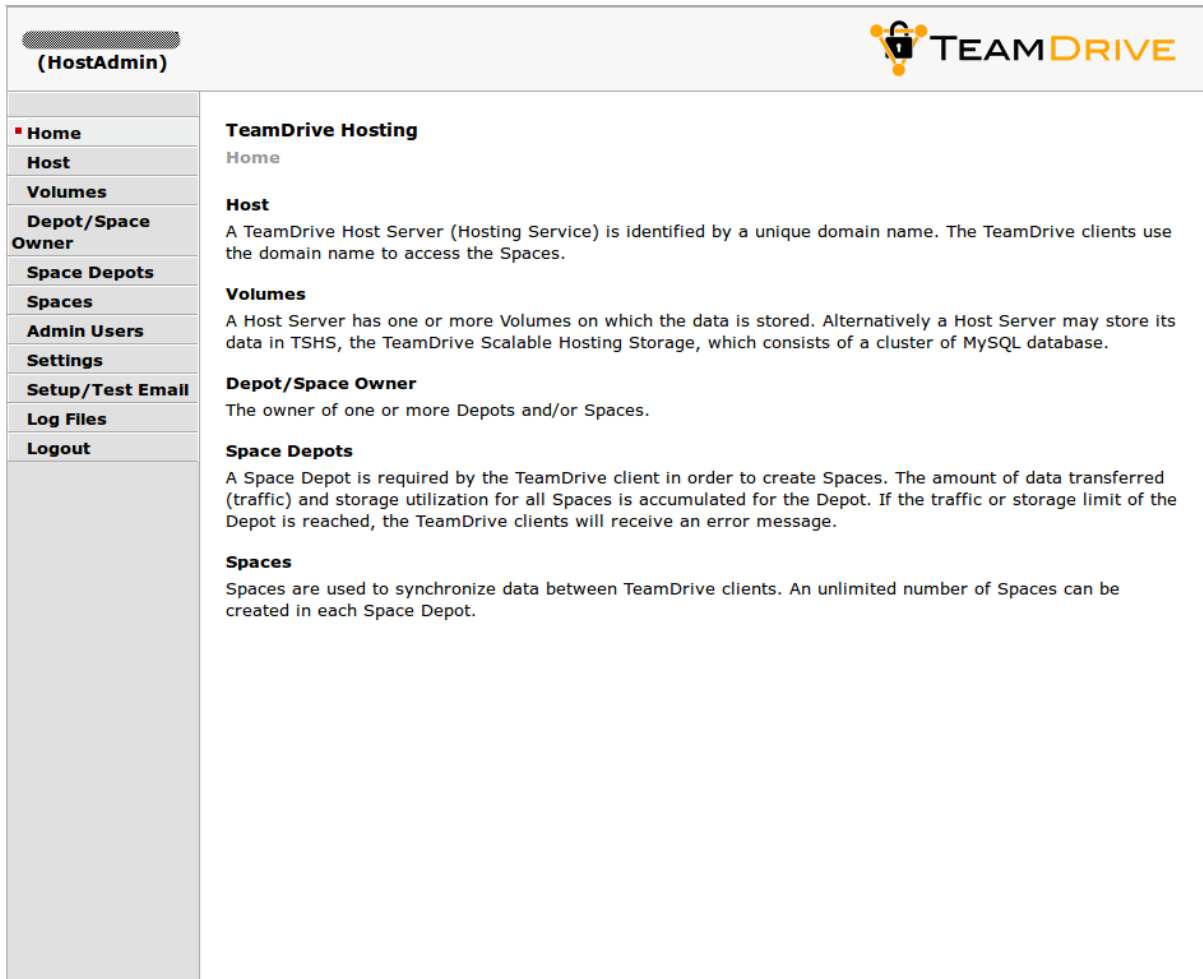

Fig. 11.5: Host Server Admin Console: Home Screen

11.3 Associating the Host Server with a Provider

As a final step, you need to associate your host server with your provider account on the Registration Server. This can be performed via the Registration Server's Admin Console, which you can usually access via the following URL:

<https://regserver.yourdomain.com/adminconsole/>

Please see the Registration Server Manual for details.

Log in with your provider login and click the tab **Edit Distributor Settings** (Registration Server version 3.0.017 and older), **Edit Provider Settings** (Registration Server version 3.0.018) or **Server Management -> Provider Settings** (Registration Server 3.5).

In the section **Provider Settings**, click the Button labelled **HOSTSERVER**.

Change the configuration setting `HAS_DEFAULT_DEPOT` from `False` to `True` and click "Save".

The `HOST_SERVER_NAME` setting and related options should now appear in the list of **HOSTSERVER** settings. Select your host server from the selection list and click "Save" to apply this change.

If required, adjust the other settings from the **HOSTSERVER** category to match your requirements, e.g. `HOST_SERVER_URL`, `HOST_DEPOT_SIZE` and `HOST_TRAFFIC_SIZE`.

11.4 Testing Client Access

The Host Server has now been set up. To test its functionality, start a TeamDrive Client and create or log into a user account belonging to the Provider Code this Host Server has been associated with.

When creating a new space, the Host Server should now be available in the "Server" selection list of the Client's "Create a Space" dialogue.

After the space has been created, take note of the Server URL and Space ID in the Client's Space Information panel. The URL should point to the host name of your Host Server.

On the Host Server, a directory with that Space ID as the directory name should have been created in `/spacedata/vol01/`. If you add files to this Space via the TeamDrive Client, the encrypted versions should appear in the respective Space's `data` directory shortly afterwards.

Also try publishing a file (requires a Professional Client License), the file should be uploaded to the Host Server in unencrypted form and placed into a subdirectory below the `public` directory of that space. Try downloading the file using the URL provided. Again, the URL should point to your new Host Server.

POST-INSTALLATION TASKS

12.1 Startup Sequence / Dependencies

To ensure a proper service start and to minimize error messages on the TeamDrive Client side, the following startup sequence of the TeamDrive Enterprise Server components and services should be observed.

1. Start the TeamDrive Host Server services in the following order:
 - (a) Mount the Space Volumes (e.g. NFSv4, local/virtual disks)
 - (b) Start the Host Server MySQL database service
 - (c) Start the `td-hostserver` background service
 - (d) Start the Apache HTTP Server
2. Start the TeamDrive Host Server services as outlined in the *TeamDrive Host Server Installation Guide*.

12.2 Starting the Apache HTTP Server at Boot Time

To ensure that Apache HTTP Server starts up automatically at system bootup time, use the following command to enable it:

```
[root@hostserver ~]# chkconfig httpd on
```

Note: It's important, that the MySQL service starts before the Apache will start. On CentOS 7 edit the file:

```
/lib/systemd/system/httpd.service
```

and add at the end of the line starting with `After=` the entry `mysqld.service`. This will ensure, that the Apache will start after the MySQL service.

12.3 Starting TeamDrive Service at Boot Time

To start the TeamDrive Host Server background service `td-hostserver` at boot time, use the following command to enable it:

```
[root@hostserver ~]# chkconfig td-hostserver on
```

12.4 Next steps

This concludes the basic installation and configuration of the TeamDrive Host Server. Please consult the *TeamDrive Host Server Administration Guide* for additional information on advanced administrative tasks and configuration steps.

TROUBLESHOOTING

Note that SE-Linux in the standard setup will prevent Apache from writing to the Host Server logs.

In addition, the firewall in the standard setup will block access to Apache.

13.1 List of relevant configuration files

/etc/httpd/conf.d/td-hostserver.httpd.conf: The configuration file that loads and enables the TeamDrive Host Server-specific modules for the the Apache HTTP Server:

- `mod_pspace.so`: this Apache module provides the actual Host Server functionality by accepting incoming data from the TeamDrive clients as well as delivering data to other clients upon request.
- `mod_yvva.so`: this Apache module is responsible for providing the web-based Host Server Administration Console as well as the Host Server API interface.

/etc/logrotate.d/td-hostserver: This file configures how the log files belonging to the TeamDrive Host Service are being rotated. See the `logrotate(8)` manual page for details.

/etc/td-hosting.conf: This file defines how the `td-hostserver` background service is started using the `yvvad` daemon.

/etc/td-hostserver.my.cnf: This configuration file defines the MySQL credentials used to access the `pspace` MySQL database. It is read by the Apache modules `mod_yvva` and `mod_pspace` as well as the `yvvad` daemon that runs the `td-hostserver` background tasks and the `yvva` command line client.

/etc/yvva.conf: This configuration file contains configuration settings specific to the Yvva Runtime Environment that are shared by all Yvva components, namely the `mod_yvva` Apache module, the `yvvad` daemon and the `yvva` command line shell.

/etc/tshs.conf: This configuration file defines a number of maintenance tasks performed by the `tshs` background service.

13.2 List of relevant log files

In order to debug and analyse problems with the Host Server configuration, there are several log files that you should consult:

/var/log/td-hostserver.log: The log file for the Yvva Application Server module which provides the web-based Host Server Administration Console and API. Consult this log file when you have issues with associating the Host Server with the Registration Server, errors when issuing API requests or problems with the Administration Console. You can increase the amount of logging by changing the Yvva setting `log-level` from `error` to `trace` or `debug` in `/etc/httpd/conf.d/td-hostserver.httpd.conf`:

```
<Location /yvva>
  SetHandler yvva-handler
  YvvaSet root-path=/opt/teamdrive/hostserver
  YvvaSet mysql-cnfile=/etc/td-hostserver.my.cnf
  YvvaSet log-file=/var/log/td-hostserver.log
  YvvaSet log-level=error
</Location>
```

After changing these values, you need to restart the Apache HTTP Server service using `service httpd restart`.

This log file is also used by the `td-hostserver` background task. Check this one to verify that background tasks are being processed without errors. The log file location can be configured by changing the file name passed to the `log-file` option in the configuration file `/etc/td-hosting.conf`. The log level can be increased by changing the default value `error` for the `log-level` option to `trace` or `debug`. Changing these values requires a restart of the `td-hostserver` background process using `service td-hostserver restart`.

/var/log/mod_pspace.log: This log file contains error messages related to the `mod_pspace` Apache module, particularly when using an compatible object store or TSHS. It needs to be writable by the user that the Apache HTTP Server runs under (`apache` by default). The log file location is configured by the server setting `ModuleLogFile` and the amount of logging can be changed by adjusting the server setting `ModuleLogLevel` via the Host Server Administration Console. The value defines the maximum level of logging of messages logged: 1 = Error, 2 = Warning, 3 = Notice, 4 = Trace, 5 = Debug. Changing these values requires restarting the Apache HTTP Server.

/var/log/httpd/: The Apache HTTP Server's log files (e.g. `error_log`) might also contain additional relevant error messages (e.g. from `mod_pspace`) that should be checked. The amount of logging is affected by the `ModuleLogLevel` setting described above.

/var/log/tshs.log: This log file contains errors and other messages generated by the `tshs` background service. The log file location and amount of output are defined in file `/etc/tshs.conf`, via the options `log-file` and `log-level`. Possible values in the order of verbosity are `protocol`, `error`, `warning`, `trace`, `debug`. The default is `warning`.

/var/log/s3d.log: This log file is written by the TeamDrive S3 daemon `s3d` and provides log messages and errors specific to the `s3d` background service. The log file location is defined in the init script `/etc/init.d/s3d`.

13.3 Enable Logging with Syslog

As outlined in list of relevant log files, the TeamDrive Host Server logs critical errors and other notable events in various log files by default.

Starting with Host Server version 3.5 and Yvva 1.2, it is now possible to redirect the log output of some server components to a local `syslog` instance as well.

Note: Please note that other components of the TeamDrive Host Server, e.g. `mod_pspace`, `s3d` or `tshs` currently do not provide `syslog` support. This limitation may be lifted in future versions of the TeamDrive Host Server software.

Syslog support is an essential feature for auditing, security and/or compliance reasons, as it allows you to funnel all log messages into a centralized `syslog` server.

This makes it easier to monitor the logs for critical events or errors and prevents tampering with the log files in case of a security breach. It also helps to maintain control over the disk space utilization on the server, as growing log files can't accidentally fill up the file system.

To enable syslog support, the log file name in the `log-file` setting has to be replaced with the keyword `syslog`. Optionally, a custom process identifier can be supplied, by appending it to the `syslog` keyword, using a colon as the separator, e.g. `log-file=syslog:my_process_identifier`. If not used, the default process identifier will be used, which is the name of the program executable.

To enable syslog support for the Yvva-based `td-hostserver` background service, edit the `log-file` setting in file `/etc/td-hosting.conf` as follows:

```
log-file=syslog:td-hostserver
```

You need to restart the `td-hostserver` background service via `service td-hostserver restart` in order to activate this change. If the `log-level` is set to `debug` you will now see log messages appearing in `/var/log/messages`:

```
Jun 23 11:57:33 localhost td-hostserver: notice: yvvad startup
Jun 23 11:57:33 localhost td-hostserver: notice: Using config file:
/etc/td-hosting.conf
Jun 23 11:57:33 localhost td-hostserver: notice: No listen port
Jun 23 11:57:33 localhost td-hostserver: notice: yvvad running in repeat 60
(seconds) mode
```

To enable syslog support for the Host Server API and Administration Console, edit the `YvvaSet log-file` setting in file `/etc/httpd/conf.d/td-hostserver.httpd.conf`:

```
YvvaSet log-file=syslog
```

You need to restart the Apache HTTP Server via `service httpd restart` in order to activate this change. If the `log-level` is set to `debug` you will now see log messages appearing in `/var/log/messages`:

```
Jun 23 12:06:04 localhost mod_yvva: notice: mod_yvva 1.2.1 (May 21 2015
11:00:12) startup OK
```

13.4 Tracing Client Accesses to a Single Space

For debugging issues with a specific Space, it might be useful to enable more verbose tracing of activity between the Host Server and the TeamDrive Clients accessing this Space.

For this purpose, access to that Space can be traced by providing the Space's ID to the option `watched_space_id` in `/etc/httpd/conf.d/td-hostserver.httpd.conf` as follows:

```
<Location /primespace>
  SetHandler pspace-handler
  MySQLCnf /etc/td-hostserver.my.cnf

  watched_space_id <space ID>

  # Necessary to ignore the extra Range-header
  # (see Range-header note in the documentation)
  RequestHeader unset Range
</Location>
```

Restart the Apache HTTP Server with `service httpd restart`. Any activity on the selected Space will now be logged into the log file `/var/log/mod_ospace.log`.

Note: Remove this option and restart the Apache HTTP Server once you've finished analyzing the problem, to avoid uncontrolled growth of the log file.

13.5 Common errors

13.5.1 Web Installation: “500 Internal Server Error”

This error can be triggered by several error conditions. Check the log file `/var/log/td-hostserver.log` for details.

Note: If there is **no error in the log**, then the problem may be that SELinux is still enabled. Please see: [Disable SELinux](#) (page 15) for details.

Some common errors include:

```
[Error] -12036 (2002): Can't connect to local MySQL server through socket
'/var/lib/mysql/mysql.sock' (25)
[Error] "startup.yv" (80)
```

The local MySQL Server’s socket file can’t be opened. This could either be a permission problem, or the MySQL Server is simply not available. Check that MySQL is actually up and running (e.g. by running `service mysqld status`) and restart it, if necessary. If the error persists, check the MySQL error log file (usually `/var/log/mysqld.log`) for hints.

Similarly, an error like the following one indicates that a remote MySQL Server might not be answering (e.g. because of a firewall rule or because it’s not running):

```
[Error] -12036 (2003): Can't connect to MySQL server on
'mysql.yourdomain.com' (107)
[Error] "startup.yv" (80)
```

If you see `Access denied` errors like the following one:

```
[Error] -12036 (1045): Access denied for user 'teamdrive'@'localhost' (using
password: YES)
[Error] "startup.yv" (32)
```

Either the username or password used to connect to the MySQL Server are wrong. Double check that the MySQL username and password provided in `/etc/td-hostserver.my.cnf` are correct, e.g. by trying to connect to the MySQL server using these credentials with the `mysql` command line client.

If you see the following error when connecting to a remote MySQL Server:

```
[Error] -12036 (1130): Host 'regserver.yourdomain.com' is not allowed to
connect to this MySQL server
[Error] "startup.yv" (80)
```

Check the TeamDrive MySQL user’s privileges on the remote MySQL server, e.g. by running `SHOW GRANTS FOR `teamdrive`@`regserver.yourdomain.com``; and make sure that this user is allowed to connect to the MySQL server from the Registration Server’s host.

13.5.2 Errors When Registering the Host Server

If the Host Server Registration fails, check `/var/log/td-hostserver.log` on the Host Server as well as `/var/log/td-regserver.log` on the Registration Server for hints (`/var/log/pbt_mod.trace` for Registration Server versions before version 3.5). See the Troubleshooting chapter in the Registration Server Installation Manual for details.

13.5.3 MySQL Errors When Upgrading From an Older Host Server Version

If you observe Access denied or Unknown database errors from the MySQL server like the following ones after starting the updated TeamDrive Host Server using an older MySQL table structure:

```
[Note] DROP DATABASE pbpg;
[Error] -12036 (1044): Access denied for user 'teamdrive'@'localhost' to
database 'hostapilog'
[Error] "plsetup.pbt" P1Setup:upgradeSettings(328)
[Error] "plsetup.pbt" P1Setup:setupDatabase(14)
[Error] "plsetup.pbt" (506)
```

Unknown database:

```
[Error] -12036 (1049): Unknown database 'hostapilog'
[Error] "plsetup.pbt" P1Setup:upgradeSettings(328)
[Error] "plsetup.pbt" P1Setup:setupDatabase(14)
[Error] "plsetup.pbt" (506)
[Error] "pl_shared.pbt" (2)
```

Double check that the hostapilog database actually exists and that the teamdrive user has the required privileges to access it.

Create the database using `CREATE DATABASE hostapilog;` and grant the required privileges using `GRANT ALL PRIVILEGES ON `hostapilog`.* TO 'teamdrive'@'localhost';`. Restart the TeamDrive Service again using `service td-hostserver restart`, it should now conclude the schema conversion.

If you observe a Can't connect to local MySQL server error like the following one in `/var/log/httpd/error_log`:

```
[notice] mod_ospace 1.6.17 Loaded; Build May 6 2015 12:42:39;
Crash-Reporting-Disabled
[error] Failed to boot Admin API: MySQL 2002:
Can't connect to local MySQL server through socket
'/var/lib/mysql/mysql.sock' (2)
```

or in `/var/log/td-hostserver.log`:

```
[Error] -12036 (2002): Can't connect to local MySQL server
through socket '/var/lib/mysql/mysql.sock' (2)
```

Double check that the MySQL Server is up and running and that the socket configuration setting in the `[mysqld]` group in `/etc/my.cnf` matches the one in `/etc/td-hostserver.my.cnf`.

The default value is `/var/lib/mysql/mysql.sock`. If the value in `my.cnf` is different, e.g. `/tmp/mysql.sock`, we suggest to revert back to the default value there instead of changing it in `td-hostserver.my.cnf` (unless you have an explicit reason to change the default socket path, of course).

Restart MySQL and the TeamDrive Hosting Services after changing this value.

13.5.4 Admin Console: Clicking on “Host” Results in a “500 Internal Server Error”

If you observe an error message like the following when clicking on **Host** in the Host Server Administration Console:

```
500 Internal Server Error
ERROR -1: TshsMain: void CSDBConn::connect(CSDB.cc:1116) MySQL 1044: Access
denied for user 'teamdrive'@'localhost' to database 'tshs_admin'
```

Or:

```
500 Internal Server Error
ERROR -1: TshsMain: void CSDBConn::connect(CSDB.cc:1116) MySQL 1049: Unknown
database 'tshs_admin'
```

You likely changed the setting `TSHSEnabled` to `True`, but did not configure the MySQL settings for accessing the `tshs_admin` database in `/etc/td-hostserver.my.cnf`.

If you changed the setting by accident, simply set `TSHSEnabled` back to `False`.

Otherwise, consult the chapter *TeamDrive Scalable Hosting Storage* in the Team Drive Host Server Administration Guide for details on how to enable and configure TSHS properly.

13.5.5 “Duplicate key” MySQL errors when updating the database

If you observe “Duplicate key” errors in the `Traffic` or `Owner` tables when upgrading these to the latest schema version, you first need to manually remove the duplicates via the MySQL client or another tool like MySQL Workbench. Older versions of the Host Server database schema did not have `UNIQUE` constraints on some columns, which caused the creation of duplicate entries. For the `Traffic` table, this usually only affects older traffic accounting information that can safely be removed.

Duplicates in the `Owner` table are likely caused by user names or email addresses that refer to the same user account, but using different capitalization. In this case it helps to cross-reference the affected users with their information in the Registration Server Database - likely one of these accounts has not been actively used and can be deleted. Please contact support@teamdrive.net if you need assistance in resolving these conflicts.

13.5.6 Admin API Error: MySQL 1040: Too many connections

On a busy server, you might observe one of the following error messages in the Apache HTTP Server’s error log file from time to time:

```
[error] Failed to boot Admin API: MySQL 1040: Too many connections
[error] [client xxx.xxx.xxx.xxx] (500)Unknown error 500: Admin API Error:
MySQL 1040: Too many connections
```

In `/var/log/td-hostserver.log` you might observe a similar error:

```
[Error] -12036 (1040): Too many connections
[Error] "startup.yv" (80)
```

This error indicates that the number of child processes spawned by the Apache HTTP Server (e.g. when many TeamDrive Clients attempt to connect to the Host Server concurrently), causes the MySQL Server to run out of threads for handling the incoming database connections.

By default, the MySQL Server is configured to accept 151 concurrent connections. Each Apache child process can establish up to two MySQL connections (one for `mod_ospace` and one for `mod_yvva`, depending on what kind of requests it needs to serve). Therefore, the maximum number of connections should be adjusted to be at least 1.5 times the maximum number of child processes spawned by the Apache HTTP Server (defined by the `MaxClients` directive in the Apache HTTP Server configuration file `/etc/httpd/conf/httpd.conf`).

The value can be changed by adding the system variable `max_connections` to the `[mysqld]` configuration group in the MySQL Server configuration file `/etc/my.cnf`, e.g.:

```
[mysqld]
datadir=/var/lib/mysql
max_allowed_packet=4M
max_connections=350
socket=/var/lib/mysql/mysql.sock
user=mysql
```

You need to either restart the MySQL server in order to apply this change, or change the value at run-time, by running the following SQL statement as the MySQL root user:

```
mysql> SET GLOBAL max_connections=350;
```

Keep in mind that increasing the maximum number of connections also increases the memory requirements of the MySQL Server. For more details, please consult the MySQL Server and Apache HTTP Server documentation:

<https://dev.mysql.com/doc/refman/5.6/en/too-many-connections.html>

https://httpd.apache.org/docs/2.2/mod/mpm_common.html#maxclients

<http://fuscata.com/kb/set-maxclients-apache-prefork>

14.1 Abbreviations

PBT PrimeBase Talk is an object oriented language specifically designed for the programming of “server-side” functionality common to intra- and internet Web sites. A large share of the TeamDrive Host and Registration Server functionality is implemented in PBT. The code is parsed and executed by the Yvva application server components.

SAKH Server Access Key HTTP for TeamDrive 2.0 Clients

TDNS TeamDrive Name Service

TDRS TeamDrive Registration Server

TDSV Same as **SAKH**, but for TeamDrive 3.0 Clients: TeamDrive Server

TSHS TeamDrive Scalable Hosting Storage.

RELEASE NOTES - VERSION 4.X

15.1 Change Log - Version 4.0

15.1.1 4.0.6 (2023-05-24)

- The distributor code for the space and depot owner is now returned to the client by the “get statistic” call (HOSTSERVER-869).
- Added new “CLIENT” settings: `DisableSnapshotsList` and `DisableReadConfList` (HOSTSERVER-866).

Snapshots are disabled for all spaces in a Depot if the provider of the Depot owner is in the `DisableSnapshotsList` list.

Read Confirmation are disabled for all spaces in a Depot if the provider of the Depot owner is in the `DisableReadConfList` list.

By default both settings are set to: `HODR`, `HDGU`, `XHDR`, `XHDG`.

- Meta data handling has been changed to include the functionality of Host Server 4.1 (HOSTSERVER-865). Meta types are now classified as follows:
 - **<=0**: Invalid
 - **1-599**: Enabled by default & Supports change notification
 - **600-999**: Disabled by default & Supports change notification
 - **1000-1399**: Disabled by default & No change notification
 - **1400-1999**: Enabled by default & No change notification
 - **2000+**: Invalid

In addition, meta data values other than 1 (Soft Lock) and 1000 (Read Notification) will now be deleted if they reach the specified “max age”.

15.1.2 4.0.5 (2022-11-16)

- Corrected the reply in the case where “getlog” is called with an out-of-date recovery number (HOSTSERVER-863).

15.1.3 4.0.4 (2022-09-21)

- Fixed a problem regarding support for clients with version number 5.0.0 or later (HOSTSERVER-861).
- Added function to check if a space is missing BLOB data (HOSTSERVER-853).

- The Host Server no longer needs to be upgraded after installation (HOSTSERVER-857). Previously, the admin was required to run “upgrade_now”, after installation. These steps are now executed automatically after installation. An upgrade of an existing Host Server still requires a manual “upgrade_now” execution.
- Settings `RegServerURL` and `ServiceHostURL` while now default to the HTTPS protocol unless explicitly specified in the setting as HTTP (HOSTSERVER-858).
- Added “Cleanup Uploads” autotask which removes partial uploads to the Object Store that are no longer required (see cleanup-uploads).

The new setting `LastUploadCleanup` indicates the last time this task ran. You can restrict the run time of the task using the `UploadCleanupTimeout` setting which is set to 40 minutes by default.

15.1.4 4.0.3 (2022-06-09)

- Space global ID’s generated must be 32 bytes long. This is required by older TeamDrive clients.

15.1.5 4.0.2 (2022-03-09)

This release also includes a number of security improvements, please contact TeamDrive for further details.

- TeamDrive Protocol (TDP) v1 will be automatically disabled for Depots that are not accessed by TeamDrive 3 clients for 6 months (HOSTSERVER-828).
TDP v1 can now also be manually disabled for a Depot in the Admin Console.
- Updated MariaDB connector (native MySQL client libs) (HOSTSERVER-839).
- Fixed a bug which lead to “provider users” referenced from the history to be marked as deleted.
- Ensure that an error is written to the various Host Server logs if a database upgrade is required (HOSTSERVER-843).
- Fixed a bug which caused an exception of the form: “Type mismatch in delete file attempt: ...”, and prevented deletion of a space on S3 storage.
- If initialisation of S3 fails in apache module then the TDP v3 protocol will now no longer return an error on every request. Instead an error is only returned when access to S3 is actually required (HOSTSERVER-849). This means that uploading BLOBs and downloading recently uploaded BLOBs of a space still work, if S3 is offline.

15.1.6 4.0.1 (2021-10-08)

This is a security update.

- A number of security issue have been fixed, please contact TeamDrive for further details.
- Logging functions now encode r and n characters to prevent “Log Poisoning” (HOSTSERVER-835).

15.1.7 4.0.0 (2021-08-31)

The Host Server 4.0 requires the YVVA runtime version 1.5.8 or later.

Note that as of version 4.0, the database must now be upgraded manually using the `upgrade_now; ;` command on the YVVA console (see `upgrade_the_database`).

Host Server Functionality

- Set security headers in Apache configuration (HOSTSERVER-821).
- The Host Server will now pause up to 5 seconds before sending the reply to the client if the download limit is exceeded, see `downloadlimit` (HOSTSERVER-808).

If the limit is exceeded, the Host Server will send an email to all System Administrators that receive emails. This notification is sent at most, once per hour.

- Depot overflow behavior has been changed significantly in 4.0 (HOSTSERVER-795)

The Host Server now allows upload of files to continue when the depot of a space is over the 100% limit. However, files uploaded in this time may not be downloaded by clients. Only once the depot is below the 100% limit are those files released for download. Files uploaded before the overflow may always be downloaded.

Depots now have an “overflow limit” and a “maximum overflow upload rate” which apply when the depot is full. This value depends on the actual depot storage limit as follows:

Depot limit	Overflow limit	Max Upload Rate
< 3 GB	10 GB	1 GB per day
< 120 GB	50 GB	2 GB per day
>= 120 GB	100 GB	4 GB per day

When a depot reaches the depot limit plus the overflow limit, the depot is “frozen”. When a depot is frozen upload and download of files is no longer permitted. This means that the only way to “unfreeze” a depot is to increase the depot storage limit.

In the frozen state deleting files, snapshots or emptying the trash may not work because of file uploads that may be queued before these operations prevent the operations from being synchronised.

A number of emails are sent to the owner of the depot, the managers of the account that owns the depot, and to certain administrators of the Host Server. In the Admin Console you can mark an Admin User as a receiver of “Email Notifications”. By default, this is enabled for all administrators.

Emails are sent when the storage exceeds 20% and 50% of the overflow limit, and when it exceeds 100% of the overlimit an email is sent to inform users and managers that the depot has been frozen.

Note that these emails are in addition to the warning emails send when the depot is 80% and 100% full, however these emails are not sent to the Host Server administrators.

- The Host Server nows sends a notification emails to the depot owner, and managers of the account that owns the storage usage exceeds 80% and 100% of the storage limit (HOSTSERVER-768).
- The Host Server also sends notification emails if the depot network traffic reaches 80%, and when traffic exceeds the limit (HOSTSERVER-793). Emails are sent to the depot owner and to managers of the account that owns the depot.

The 100% usage notification is also sent to Host Server administrators that have been selected to receive email notifications.

- Added functionality to recalculate the size used by a space, on disk and in the cloud (HOSTSERVER-738).

Buttons are provided in the Admin Console to initiate the calculation of disk usage for a space and for all spaces in a depot.

After a space has been restored, recalculation of disk usage is automatically scheduled.

Depot size recalculation is triggered if a depot exceeds 100% storage usage, and the size of the depot has not been recalculated in the last 180 days.

- This version implements Amazon Signature Version 4. This can be enabled by adding the option `UseSignatureV4=True` to the `S3Options` setting (HOSTSERVER-766).

Note that this signature type only works for Amazon (and fully Amazon compatible) object stores, Azure and OpenStack still use the Version 2 signatures.

- Added the `S3Region` setting which determines the region used in Amazon Version 4 signing process. By default the value “eu-west-1” is used.

The region must be set according to the following mapping: [Amazon Regions and Endpoints](#)

- The Host Server will now automatically delete spaces in a depot to reduce disk usage, when the limit of a depot is exceeded by a certain amount (HOSTSERVER-759). See `space_reduction` for details.

Two settings have been added to support this feature: `EnableSpaceReductionProcess`` and ```AllowAutoDeleteSpaces` (see `resource_management_settings` for details).

Spaces will not be deleted if the depot has been active within the last 6 months.

- The Apache module and the `s3d` service now check the database version. If the database structure is not up-to-date the Apache module generates an error, but will continue normally as soon as the database is updated. The `s3d` quits if the database version is not the required version, currently this is version 3.7 level.
- Added `TransferConnection` setting which is used to support the transfer of the Host Server Object Store to a different service provider (see `transferconnection`) (HOSTSERVER-771).
- Added the `UseIPWorks` setting (default: `False`). Set this value to `True` in order to use the IPWorks-based cloud access implementation.
- Added various binary hardening measures. Maximum POST request size for API calls is now 10 MB.

Administration Console

Note: Please clear the browser cache after the server update.

- You can now specify whether snapshots should be enabled or disabled for a new space on the depot level. Here you can choose between always enabling or disabling snapshots for spaces created in the depot, or you can make it depending on the value of the `EnableSnapshotsByDefault` setting. This is the default (HOSTSERVER-785).

Note that changing this value does not change whether snapshots are enabled or not for existing spaces.

- Using “Set Space Status” and “Unset Space Status” on the space depot page, you can now set and remove a status from all spaces in a depot. The status that may be set/removed are: “Disabled”, “Readonly”, “Deactivated for maintenance” and “Deactivated by provider” (HOSTSERVER-761).
- On the Space Depot page the “Recalc Depot Size” button can be used to initiate the recalculation of the sizes of all spaces in the depot. This process is performed in the background and may take a while.
- On the Space Details page you can use the “Recalculate Disk Usage” button to initiate recalculation of the disk space used. This process is performed in the background and may take a while.
- On the Space Depot page, the “Restore Spaces” button may be used to undelete all spaces in the depot. This function can be used after restoring the space of a depot from backup.

If the space directory does not exist on disk, then the space cannot be restored, and this will cause the process of restoring spaces to stop.

An empty space directory will be restored as an empty space. After restoring a space, recalculation of the disk space of the space will be initiated.

- It is now possible to set a volume space limit to 0, which means unlimited.
- The Admin Console can now “rollback” a failed restore snapshot attempt (HOSTSERVER-807). This case is clearly shown in the Admin Console, if the space is in the “Restoring” state, and a notice on the space indicates that a restore to snapshot is in progress. If this operation is not completed within a few minutes it is OK, to press the “Space Restored” button, to undo any changes to the space log files.
- The Object Store key (setting `S3SecretKey`) is no longer shown completely in the Admin Console for security reasons (HOSTSERVER-813).

RELEASE NOTES - VERSION 3.X

16.1 Change Log - Version 3.7

16.1.1 3.7.11 (2021-02-18)

- Fixed a bug in the cleanup code of s3d, that is used after space rollback. A directory object returned from S3 was not correctly handled.
- The Apache module (mod_ospace) will now retry S3 startup (object store access) if this fails on startup of the module (HOSTSERVER-781).
- Updated jquery.js version to 3.5.1 (HOSTSERVER-788).
- Added download logging (HOSTSERVER-787). This functionality can be used to limit the number of downloads of a file, from a certain client device in a certain amount of time. Published files are not effected by this limit.

If the download quota is exceeded, the Host Server returns a HTTP_TOO_MANY_REQUESTS (429) error.

New settings (EnableDownloadLogging, DownloadLimit, DownloadLogGrouping, DownloadLogRetention and DownloadRatePeriod) allow this to be configured globally for the Host Server.

Download logging can also be enabled at the Depot level by setting a “download limit”. This value overrides the global DownloadLimit setting. See download_logging for details.

In the Admin Console the download log can be viewed and queried from the “Log Files” menu item.

16.1.2 3.7.10 (2020-05-15)

A number of changes have been made to prevent the publishing of a web-site using the publish file functionality (HOSTSERVER-770). This includes:

- Added the EnableDirectLink setting which makes it possible to disable the direct link feature (dl=1).
- Added the ForceDownloadList setting: This a list of content types and file endings that force a download in place of displaying the file in the browser.
- Added the PublicRewritesInstalled setting which indicates that certain re-write rules have been added to the Host Server, which allow the TeamDrive client to generate public URLs that vary in the first component depending on the space (see publicrewritesinstalled).

16.1.3 3.7.9 (2019-07-19)

- The S3 server name (setting S3Server) may now be specified as a URL, not just a domain. This allows you to set the protocol to HTTPS, and specify an alternative port (HOSTSERVER-767).

If a protocol is specified in the URL, then this overrides the value of the S3RedirectProtocol setting.

- Fixed the setting `S3RedirectProtocol`, which was ignored by the Host Server apache module (`mod_pspace`).

16.1.4 3.7.8 (2019-03-29)

- `S3Daemon`: Set `CURLOPT_NOSIGNAL` in order to prevent crash which occurs when libcurl receives a signal due to a timeout in domain lookup
- Set `yvva` dependency to 1.4.6

16.1.5 3.7.7 (2019-02-26)

- A unique index has been added to the `Owner.UserName` field where it was missing (HOSTSERVER-763).
- If `HttpsUsedByPublish` is set to `True`, the Host Server will now return an error when trying to access a published file using HTTP (instead of HTTPS) (HOSTSERVER-762).
- An error occurred when adding/removing a large number of users to/from a depot. This is due to field size limitations in the `RepositoryChanges` table. Excessively long user lists are now truncated, and the suffix: `”, ... and N others”` is added (REGSERVER-1379).
- The `“getdepotdata”` API call was incorrectly returning the `“ ”` HTML entity in the `<changelist>` details.
- Fixed a bug when setting the owner of a repository, if the repository had no a history entry was not created.
- Added timeouts for all S3 operations. The connection timeout is set to 2 minutes, and the timeout for the entire S3 operation is set to 30 minutes (HOSTSERVER-758). This is to prevent the background task from hanging in the request to get the S3 logs.
- Returning data from encrypted files could hang in `Tdp3File::send_file()` if there was an error on the channel (HOSTSERVER-760).

16.1.6 3.7.6 (2018-10-22)

- Fixed a bug in the calculation of Space disk usage when correcting spaces that have a negative disk usage. The bug resulted in a overflow error being thrown by the `“Check Spaces with Limit”` auto task (HOSTSERVER-757).
- Fixed a bug when deleting an owner (user that has been deleted on the Registration Server): if the user was a user of a depot, then: either (1) the user was not removed or (2) a repository history entry was not inserted.

16.1.7 3.7.5 (2018-10-11)

- Spaces marked as having a data retention period may not be deleted over the API (HOSTSERVER-751).
These spaces must either be deleted using the TeamDrive client, or on the Host Server Admin Console. Depots containing spaces with a data retention period are also subject to this restriction.
- Deleting a depot on the Admin Console will now delete all spaces in the depot.
- Undeleting all spaces and restoring all spaces belonging to a depot is now possible. When a depot contains deleted spaces the button `“Undeleted Spaces”` and `“Spaces Restored”` appear in the Admin Console on the depot page. Note that if the depot has been deleted, then you must undelete the depot first (HOSTSERVER-726).

An error will occur if you click `“Spaces Restored”`, and not all spaces in the depot have been copied back to an active volume on the host. In this case, the restore of some spaces may be complete while other remain deleted.

As before, undeleted and restore are possible at the space level, however, this will not be allowed if the repository of the space has been deleted.

NOTE! The Admin Console setting: `ShowDeletedObjects` must be set to true in order to see depots and spaces that have been deleted.

- Added `SpaceDeletionDelay` (Resource Management) setting which specifies the time between a space being deleted and it actually being removed from disk (HOSTSERVER-727). During this time the space can be undeleted.
- Added `AllowedLoginIPList` (Admin Console) setting which can be used to restrict login to the Admin Console to certain IP addresses (HOSTSERVER-723).
- HTML templates can now be customised by setting a header and a footer HTML “snippet” (HOSTSERVER-729) at the depot level.

Note that the placeholders `[[HEADER]]` and `[[FOOTER]]` have been added to the relevant HTML templates for this purpose.

The global settings: `DefaultTemplateFooter` and `DefaultTemplateHeader` are used as default values if nothing is specified for a depot.

- HTML template can use conditional sections (). This have the following form:

```
[[IF:<placeholder>]] ... [[ENDIF:<placeholder>]]
```

and

```
[[IFNOT:<placeholder>]] ... [[ENDIF:<placeholder>]]
```

where `<placeholder>` may be any valid placeholder: `HEADER`, `FOOTER`, `FILE-NAME`, `ERROR-MESSAGE`, `ERROR-CODE` and `PUBLIC-URL`.

The `IF` sections are displayed if the specified placeholder is not empty and non-zero (in, the case if `ERROR-CODE`). `IFNOT` sections are displayed if the placeholder value is empty or zero.

- Operations that append to log files now return the log offset of the position after the block written (HOSTSERVER-740).
- The Host Server now supports at rest encryption of public files.

The new HTML template: “`decryption-failed.html`”, will be returned if the public URL does not contain a correct or valid decryption key.

- The Host Server now supports “shorted URLs” for public files. A short URL may be requested before upload of a public file begins (HOSTSERVER-722).

A new HTML template has been added: “`upload-incomplete.html`”. This template is returned if upload of a public file has been started, but is not yet complete. This is necessary because, in the case of large files, the TeamDrive Client may make the public URL available before the upload is complete.

Note: For short URL public files to work correctly, you must remove the `action="..."` attribute from the `<form>` tags, in the “`enter-password.html`” and “`password-wrong.html`” templates. The default templates have already been updated.

- Published files are now encrypted at rest. The key must provided in the URL on upload and download (HOSTSERVER-732).

16.1.8 3.7.4 (2018-07-17)

- Fixed crash in background task when a Registration Server was not available during synchronisation of owner data (HOSTSERVER-720).
- The “`getdepotdata`” API call now returns a `<flags>` tag which may include the `restrict-access` flag value (see `getdepotdataRef` for details).

- The “createdepot” API call no longer automatically creates a “contract number” for a depot which starts with “WEB#”.
- Fixed a bug that prevented the synchronisation of data with foreign Registration Server. The error in log was: “RROR -24903 (0): Authorization failed: device 99999 not found” (HOSTSERVER-725).
- When moving spaces from one depot to another, then disk usage and traffic was not always recalculated correctly (HOSTSERVER-731).
- Under certain circumstance published files that were part of a snapshot were not deleted after expiry, although access to the file was prevented (HOSTSERVER-733).
- Under some circumstance the Host Server set the “Traffic limit exceeded” flag, even when the `EnforceTrafficLimit` setting was set to `False` (HOSTSERVER-735).
- The Host Server now records the name of the user that made changes to a depot. Previously this information was not always available as it was placed in the comments. This function requires the use of Registration Server version 4.0 or later (HOSTSERVER-736).

16.1.9 3.7.3 (2017-11-01)

- Improved the reporting and logging of connection errors that may occur when the Host Server contacts the Registration Server.
- During Host Server Setup it is now possible to specify a proxy to use in order to contact the Registration Server. The `NoProxyList` setting must be specified after setup, if required.
- Improved input checking on setup of the Host Server. The Registration Name may not contain in special characters. Domain Names may not contain any spaces, and must include at least one ‘.’ character (HOSTSERVER-715).

- The Host Server will now prevent access to a Depot if all users are removed from the access list. Previously, Depots reverted to unrestricted access when the last user was removed from the access list.

The Depot users in the access list are now displayed in the Admin Console. Only the Depot owner and users in this list are allowed to create Spaces in the Depot. However, users not in the list are not prevented from using existing Spaces in the Depot.

- Deleting a Depot in the Admin Console now works the same as deleting a Depot via the API: the Depot is simply marked as deleted (HOSTSERVER-712).

If the setting `ShowDeletedObjects` is `False`, then Depots marked as deleted will not be visible in the Depot list. However, such Depots can be reached by clicking on the Depot link in a Space belonging to the Depot.

Note that deleting a Depot currently just prevents new Spaces from being created in the Depot. Existing Spaces are still accessible.

- Moved index on `SpaceID`, `MetaType` from `MetaData` to `MetaDataOptions` table. This index was previously created on the wrong table (HOSTSERVER-716).
- Added support for “If-Modified-Since” header. If sent, and BLOB data has not been modified since the specified time, the server will now send a “304 Not Modified” result. This is in order to support caching proxies (HOSTSERVER-709).
- Added `NonCachingProxies` setting. This is a list of the host names or pseudonyms of proxies that are downstream from the Host Server but do not cache any data (HOSTSERVER-711).
- Version 3.7.3 requires YVVA runtime version 1.4.4.

16.1.10 3.7.2 (2017-08-14)

- The TPD v3 call “restsnap” will now delete all meta data created for the Space after the last modify time of the snapshot (HOSTSERVER-708).

- Fixed a database deadlock in TDP v3 call “addmeta” (HOSTSERVER-707).
- Moved `EnableProxyCaching` to “Client Settings” (HOSTSERVER-706).
- A space change history entry is now made when a Space is deleted (HOSTSERVER-705).

16.1.11 3.7.1 (2017-06-20)

This is the initial public release of version 3.7.

This version requires the YVVA runtime 1.4.0 or later.

Host Server Functionality

- The Host Server supports Point-in-Time recovery. Using this functionality the TeamDrive Client is able to rollback a Space to a previous point in time. See details in chapter `snapshot_backups_and_pit_recovery`.
- Added “Outgoing Connection” settings: `UseProxy`, `ProxyHost`, `NoProxyList`, `ConnectionTimeout` and `NetworkTimeout` (see `outgoing_connections`) (HOSTSERVER-676).
- Added support for Read Notifications. Read Notifications are disabled by default for all Spaces. This feature must be explicitly enabled for a Space by the TeamDrive Client.

The setting `DefaultReadNotificationMaxAge` determines the maximum age of read notifications, if this value has not been explicitly set at the Space level settings (HOSTSERVER-681).

- Fixed a bug which caused an error when moving a Space from one depot to another using the Admin Console (HOSTSERVER-680).
- When accumulating traffic, the process now checks the access time to ensure that traffic is only accumulated for the current month. This fixes the problem that the Object Store log processing can generate traffic changes that occurred in the previous month (HOSTSERVER-702).

Administration Console

Note: Please clear the browser cache after the server update.

- Snapshot relevant parameters can be set per Space. Changes are recorded in the change history of the Space.
- Read Notification settings can be set per Space. Changes are recorded in the change history of the Space.
- Added the list of background tasks (“Auto Tasks”) to the Admin Console. The list indicates when a task last ran and the result. Clicking on a task allows the user to Activate or Deactivate tasks (HOSTSERVER-697).

This page also shows the status of the Host Server services: `td-hostserver`, `s3d` and `tshs` (if active). The command used to determine the status is:

```
service td-hostserver/s3d/tshs status
```

If this system is not correctly installed an error will be displayed.

16.2 Change Log - Version 3.6

16.2.1 3.6.3 (2017-02-15)

- Admin Console: Fixed the select owner dialog on the “Space Depots: Details” page. Entering a name filter was not working (HOSTSERVER-664).
- Revised chapter Host Server Virtual Appliance with CentOS 7

16.2.2 3.6.2 (2017-01-24)

- Missing BLOBs are now logged a Trace level (HOSTSERVER-648).
- Added path and BLOB name to error log output of the v2 protocol (HOSTSERVER-649).
- Updating a Depot in the Hosting Server Admin Console could fail with the error: “Owner is empty” (HOSTSERVER-646).
- Fixed incorrect XML sent in the Reg Server search call used to retrieve owner/user details (HOSTSERVER-650).
- Removed “Space has been disabled” messages from log (HOSTSERVER-647).

16.2.3 3.6.1 (2016-11-15)

- The Host Server now retrieves details of Owners from the Registration Server. The email address and Provider Code of the Owner will be updated within 24 hours if changed in the Registration Server. So-called “magic usernames” are now only displayed when the Host Server has no email address for a user (HOSTSERVER-629).

See `sync_owner_data_task` for details.

- When adding a Space Owner in the Admin Console, the Host Server will now check that the user is a registered TeamDrive User. Note that that it is now possible to add an Owner by specifying the Email address only (HOSTSERVER-640).
- The statistics poll method now returns the Space owner details to the TeamDrive Client (HOSTSERVER-639).
- Admin Console: fixed error handling when creating an Owner using the Admin Console.
- Admin Console: fixed an error when using the Admin Console to create a new Depot.
- The Client will now be prevented from inserted Space meta data with zero length (HOSTSERVER-644).
- It is now possible to set the system settings `ServiceHostURL` and `RegServerURL` to the domain name of the Host Server or Registration Server instead of a complete URL. The Host Server will not automatically convert this to a URL as required (HOSTSERVER-645).

The setup process of the Host Server will continue to set these values to complete URLs, although the input fields during setup only require domain names.

16.2.4 3.6.0 (2016-09-01)

The Host Server 3.6 requires the YVVA runtime version 1.3.8 or later. Please follow the upgrade instructions in `upgradeto36`

Host Server Functionality

- Improved restore functionality (HOSTSERVER-635).
- The name of the user and the deletion time are now recorded when a Space is deleted (HOSTSERVER-507). Note: this only works if TDP v3 is active, and you are using TeamDrive client version 4.2 or later.
- Added system settings: `NotifyVolumeEmail`, `NotifyVolumeWarningLevel`, `NotifyVolumeCriticalLevel`. The background task, `Volume Warning`, has been added to send an email notification when the the disk usage of a volume exceeds the specified levels.
- Fixed upgrade from version 3.0.011 (HOSTSERVER-618).
- Added the setting `S3RedirectProtocol`. This setting determines the protocol to be used for redirects to S3, or other Object Stores (HOSTSERVER-622).

- Added support for Azure blob storage (HOSTSERVER-583)
- The Host now supports the “Range” header (HOSTSERVER-577). This enables the direct streaming of videos. Note, only one range per call is supported.

Administration Console

- Added functionality to restore a deleted space (HOSTSERVER-633).
- Host Server settings have now been divided into groups (HOSTSERVER-574).
- The modification time of settings is now displayed in the Admin Console (HOSTSERVER-575).

API

- Added `movespace` API call, which moves a Space to another Depot (HOSTSERVER-636).
- The `getspacedata` API call now accepts the following additional tags: `<includedeleted>`, `<resultoffset>` and `<resultlimit>` (HOSTSERVER-461).
- The `getdeptdata` API call now accepts the tags `<includedchanges>` which specifies if the change history should be returned with the details of the Depot (HOSTSERVER-497).

16.3 Change Log - Version 3.5

16.3.1 3.5.8 (2016-09-27)

- Fixed problem when using directory scan on XFS with CentOS7. The “teamdrive-volume-id” file was not being correctly created (HOSTSERVER-643).
- The volume ID is now checked on startup of the Apache module (`mod_pspace`). Previously it was only checked when a Space was created.

16.3.2 3.5.7 (2016-08-29)

Note: The Host Server version 3.5.7 requires YVVA runtime version 1.3.8 or later.

Note: Updating the Host Server on CentOS 7 with “yum update” might update the apache to a newer version. This update could re-install the deleted “conf”-files in the folder `/etc/httpd/conf.modules.d/` and will prevent starting the apache. Please follow the modified instruction to disable all modules in the “conf”-files instead of deleting them as described in `configure-apache-24`

- Fixed the “back” button after clicking on a link in the Admin Console.
- Fixed restore function: it was possible that an incorrect log offset was calculated after restore (HOSTSERVER-632).
- Organised the settings into groups in the documentation (HOSTSERVER-630). The same grouping is used in the Admin Console in Host Server 3.6.
- The Depot document returned with `SERVERFLAGS=` contained an invalid terminator. This caused the document to be incorrectly interpreted by the Client and Registration Server (HOSTSERVER-631).

16.3.3 3.5.6 (2016-07-13)

- Fixed the traffic reset task. If the setting `StatisticRest` is blank, then the task does not run. A quick workaround for this bug is to set the variable to “0”. This must be done directly in the database, on the table `pspace.Setting`, column `Value` (HOSTSERVER-623).

16.3.4 3.5.5 (2016-06-09)

- Added missing `yvva` compatibility to `td-hostserver` background task configuration file

16.3.5 3.5.4 (2016-06-07)

Note: The Host Server version 3.5.4 requires YVVA runtime version 1.3.6 or later.

- Fixed a bug that could result in the TeamDrive Client reporting traffic limit reached, when `EnforceTrafficLimit` is set to `False` (HOSTSERVER-621).
- Added support for CentOS 7 with Apache 2.4
- Fixed the link in to Volumes in the Host overview page (HOSTSERVER-619).
- Fixed dialog used to set the owner of a Depot (HOSTSERVER-616).
- Minor API documentation fix: the position of the `<etl>` tag has been changed, and the order of tags in reply’s now matches the order returned by the server (HOSTSERVER-496).
- Admin Console: The Storage and Transfer columns incorrectly showed “MiB MB” as units (HOSTSERVER-612).
- The Host Server was incorrectly setting the Volume full Status bit on Spaces, when the Depot disk limit was reached (HOSTSERVER-611). This error will be corrected automatically.
- Fixed a bug that prevented long running MD5 checks from working correctly.
- An error in the TDP version 3 prevented files from being deleted when the depot was full (HOSTSERVER-610).

16.3.6 3.5.3 (2016-02-02)

- Fixed lost password functionality in admin web interface (HOSTSERVER-604).
- Added the `DownloadContentType` setting which may be used to specify the content type of encrypted data returned by Host Server (HOSTSERVER-602).
- API function “`deletespace`” no longer returns an error when deleting a Space that has already been deleted. However, the API also does not return an error if the Space does not exist at all, or if the Space is in another Depot. In these cases, the delete call is just ignored (HOSTSERVER-429).
- Fixed a bug in `mod_pspace`: if a recently published file was deleted and then published again, the result could be that the file on the server has 0 bytes (HOSTSERVER-601).
- The tags `<disclimit>` and `<trafficlimit>` in the “`setdepot`” call are now optional.
- Added `<etl>` tag to the “`getspacedata`” API-call. The “Traffic Limit Reached” bit will also be removed from the status returned by this call (HOSTSERVER-411).

16.3.7 3.5.2 (2015-12-08)

- Fixed bug in schema definition for FileSize column in PublicFile table
- Fixed bug with comparison of timestamp to DATE value in the database because of daylight savings time corrections (HOSTSERVER-578).
- Fixed TD3 Protocol crash in loadSpaces() (HOSTSERVER-580).
- Fixed return of .tdsv files
- Fixed disk usage calculation error in case of host server is connected to an object store (HOSTSERVER-576).
- Fixed duplicate object store log files processing in case of identical or missing S3ToProcessPath and S3ProcessedPath (HOSTSERVER-586)
- Fixed adding external traffic in API-call “getspacedata” (HOSTSERVER-587)
- Fixed retrieval of public file where name contains reserved URL characters (HOSTSERVER-581)
- Correctly log last.log.lock when reading and writing log files and if no maximum len is given, return the entire log
- Fixed error when adding MOVE action to database → Illegal mix of collations (HOSTSERVER-589)
- Fixed TD3Protocol: Empty reply for getblob (HOSTSERVER-595)
- Fixed exclude “Error getting size from ...” in case of zero download for object store access log processing (HOSTSERVER-593)
- Corrected RepositoryChanges table duplicate constants
- S3Daemon: Fixed error ‘The Content-MD5 you specified did not match what we received.’ It was possible that the checksum value stored in the database did not match that of the actual file (HOSTSERVER-591).
- S3Daemon: Fixed problem with multipart uploads. If an attempt to transfer a zero length file to S3 it would fail but would try again later so it was stuck in an endless loop (HOSTSERVER-588).
- Added Functionality to move space from one depot to another. The host Admin Console now provides a “Move...” button which can be used to move Spaces to a selected Depot. A new API function, movedepotspaces(), allows the same function to be performed via the API (HOSTSERVER-546). Client version 4.1.2 required to update the new space owner correctly.

16.3.8 3.5.1 (2015-10-09)

Documentation

- Fixed description of Background Tasks
- Added ssl configuration hint in case of upgrading a server to version 3.5
- Added description for the html templates for password protected published files

Host Server Functionality

- Usability: Added a default html template folder to avoid conflicts with customized html templates (HOSTSERVER-572)
- Administration: Fixed divide by zero error in case of depot size and traffic limit are zero (HOSTSERVER-570)
- Administration: German translation is disabled. Only english web interface is supported (HOSTSERVER-569)

- Administration: The new background task for API log cleanup will be created with status enabled instead of disabled. The usage could be controlled using the setting “APILogEntryTimeout” (HOSTSERVER-568)
- Usability: Added html template “url-invalid.html” for expired or invalid token in case of access a published file (HOSTSERVER-567)
- Security improvement: Limit access to allowed log files (HOSTSERVER-564)
- S3 daemon: Added bandwidth limitation for the S3 daemon (HOSTSERVER-563)
- Administration: Added filter (<, >, =) for Space-IDs and Depot-IDs (HOSTSERVER-562)
- Administration: Added setting “APILogEntryTimeout” to define a period in days for deleting api logs (HOSTSERVER-561)
- Administration: Fixed truncated “Add New Admin User”-Button (HOSTSERVER-560)
- Administration: Fixed access to ping.xml (HOSTSERVER-558)
- Administration: Fixed s3d.log file name for log file display (HOSTSERVER-557)
- S3 daemon: Fixed crash in case of multipart upload (HOSTSERVER-556)
- Administration: Fixed displaying info text for “TimeDiffTolerance” setting (HOSTSERVER-553)

16.3.9 3.5.0 (2015-09-21)

TeamDrive Host Server Version 3.5 is the next major release following after version 3.0.013.

Note: Please note the the version numbering scheme for the Host Server has been changed starting with version 3.5. The first two digits of the version string now identify a released version with a fixed feature set. The third digit, e.g. “3.5.1” now identifies the patch version, which increases for every public release that includes backwards-compatible bug or security fixes. A fourth digit identifies the build number and usually remains at zero, unless a rebuild/republishing of a release based on the same code base has to be performed (e.g. to fix a build or packaging issue that has no effect on the functionality or feature set).

Version 3.5 contains the following features and notable differences to version 3.0.013. See [releasenotes-3.0.013](#) for a detailed description of the change history for that version.

Host Server Functionality

- Security enhancement: Files can now be published with an expiration date after which an auto task on the Host Server will automatically remove the published files again. Additionally, published files can now be protected by a password. This functionality requires support on the TeamDrive Client side, which is implemented in versions 4.1 of the TeamDrive Client. For entering the password in a html page, a few templates were added. The templates could be customized and will not overwritten when updating to a newer Host Server version.
- Security enhancement: A request for a published file no longer returns the actual file directly, except in the case where the request comes from tools like `wget` or `curl`. Instead, the document returned is an HTML file containing JavaScript calls that load the actual file using a temporary URL. This solves a potential security problem in which URLs of published documents can be inadvertently disclosed to unintended recipients in the following scenario: A TeamDrive user publishes a document that contains URLs pointing to a third-party website (e.g. a PDF or office document). The user, or an authorized recipient of the published URL, clicks on a hyperlink embedded in the document. At that point, the referrer header discloses the document’s publish URL to the third-party website. Someone with access to that header, such as the webmaster of the third-party website, could then access the link to the published document. (HOSTSERVER-316)
- A new Client/Server protocol, supporting parallel polling of Spaces for increased throughput/performance, batched delete operations (e.g. emptying the Trash) and “soft” locking of files. These features require support on the TeamDrive Client side, which is scheduled to be implemented in future versions of the TeamDrive Client.

- Performance improvement: The Host Server now uses a database table instead of action files in the Space Volume's file system for signalling actions like uploading or deleting files to the object store. As a result, `s3d` no longer has to perform a full scan of all Space Volumes to look for new or changed files. (HOSTSERVER-284) Additionally, the MD5 digest of a file is also stored in this table, so `s3d` does not need to perform a recalculation of the checksum before uploading the file to the object store. During an upgrade from a previous version, any remaining action tag files in the file system will be imported into the database. Afterwards, the server setting `ImportS3tagFiles` should be set to `False`.
- The S3 daemon `s3d` now only performs a full scan of all Space Volumes once per day by default, looking for old files to be transferred to the object store. The age of these files is set via the settings variable `MaxFileAge`. The maximum file age should be set long enough to ensure that no file that may still be in the process of being uploaded by a Client will be sent to the Object Store, otherwise the Client would have to restart the upload from scratch.

Administration Console

- Security improvement: Added support for managing multiple user/administrator accounts. There are 2 types of users: Superuser and Administrator. Only the Superuser may manage other users. The Administrator may view all users and only update his own user account. (HOSTSERVER-366)
- Security improvement: Disabled auto completion on the login form. (HOSTSERVER-379)
- Security improvement: The complexity of entered passwords is now indicated. (HOSTSERVER-374)
- Security improvement: it is now possible to enable two-factor authentication via email. If enabled, the user is required to enter a security code provided via email in addition to his username and password.
- Security improvement: On login, the user will get an error if he has another logged in session. To proceed, the user must check the checkbox titled: "Close my other login sessions". (HOSTSERVER-376, HOSTSERVER-377)
- Security improvement: The following events are now logged at the "notice" level: login, logout, failed login attempts and changes to user accounts.
- Security improvement: the amount of search results (e.g. Spaces, Depots or users) is now limited to a maximum defined by the `MaxRecordsDisplayed` setting, which can only be changed by the Superuser.
- Administration: It is now possible to change a Depot's status (e.g. enabled, disabled, deleted)
- Administration: Added support for viewing selected server log files and the Host Server API log. (HOSTSERVER-348, HOSTSERVER-243)
- Administration: It is now possible to track and display modifications made to Space Depots (e.g. via API calls coming from the Registration Server or via the Host Server Admin Console). (HOSTSERVER-388)
- Administration: When creating a new Space Volume via the Administration Console, the system now checks if the directory actually exists on the file system before creating the Volume. (HOSTSERVER-349)
- Usability: References like Depot Names, Volume names and owners in the Space list are now clickable, to improve the quick navigation between pages. (HOSTSERVER-390)
- Usability: Objects like Spaces or Depots that have been marked as deleted are now hidden in result lists by default. They can be made visible again by changing the setting `ShowDeletedObjects` from `false` to `true`. (HOSTSERVER-442)
- Usability: Administration Console now better visualizes errors like missing Space Volumes.
- Usability: Units displayed for disk space or traffic usage now use the correct units (e.g. MiB, or GiB), to avoid confusion caused by conversions between different units. Space and traffic levels are now displayed in percent instead of absolute units.

Administration / Installation

- Administration: The Host Server's log levels have been aligned with the ones used by the Registration Server and the Yvva Runtime Environment. Valid log levels are: 1 (Error), 2 (Warning), 3 (Notice), 4 (Trace), 5 (Debug). In production mode the default log level is 3 (Notice). Setting the log file name to `syslog` will now send log output to the local syslog service. You can add an optional "Log Identity" after a colon in the log file name, for example: `syslog:my-log-id`. The default Log Identity is name of the program, e.g. `s3d` or `tshs`.
- Administration: The central log file `/var/log/td-hostserver.log` is the central log location for all Yvva-based components (e.g. the Host Server API, Administration Console or `td-hostserver` background service); the log files used in previous versions (e.g. `/var/log/mod_yvva.log`, `/var/log/pl_autotask.log`, `/var/log/pbvm.log`) will no longer be used.
- Administration: TSHS now supports the additional commands `disable-s3-host`, `enable-s3-host` and `delete-s3-host` that allow for disabling/removing the synchronization of objects to an S3-compatible object store. Calling `disable-s3-host` marks a host entry as "disabled". Calling `delete-s3-host` deletes a host entry unless the entry is referenced by a file. In this case the entry will be marked as deleted. If an entry is marked as disabled or deleted, no further data will be uploaded to the object store. However, accessing existing objects from the object store will continue to work. Calling `enable-s3-host` will re-enable the synchronization of objects to the object store, including the upload of all objects that have been uploaded to TSHS while the object store was marked as disabled. If a disabled or deleted host is marked as current, then TSHS will generate an error on each write attempt.
- Administration: Added an auto task that can be enabled to send out notification emails if a Space Volume's disk utilization reaches a configurable level.
- Administration: Added an auto task that removes published files that have reached their expiry time.
- Administration: Added an auto task that can be enabled to delete API log entries older than 30 days from the `hostapilog` table.
- Installation: TSHS now supports reading options from a configuration file. The default is `/etc/tshs.conf`. The default options that were previously stored in the TSHS init script `/etc/init.d/tshs` have now been moved to the configuration file instead. (HOSTSERVER-303)
- Installation: Optionally configure email support (required when using two-factor authentication). (HOSTSERVER-437)
- Installation: The initial Host Server setup process now asks for both a user name and password for the Superuser account. (HOSTSERVER-438)
- Installation: Host Server 3.5 now requires Yvva Runtime Environment version 1.2 or later. This version is included in the Host Server's yum package repository and will be installed automatically.
- Installation: The distribution now contains the tool `mys3`, which can be used to interact with an S3 compatible object store.

API

- Changes to a Space Depot performed by the API functions `addusertodepot` and `deleteuserfromdepot` are now added to the Depot's change log.
- The MD5 checksum value calculated over API requests no longer needs to be passed in lowercase when submitting the request. (HOSTSERVER-426)
- For debugging purposes, erroneous API requests are now logged to the API requests table as well. (HOSTSERVER-465)

16.4 Change Log - Version 3.0.013

16.4.1 3.0.013.15 (2015-08-17)

- S3: Fixed bug with high IO, upload could not proceed and other uploads will be blocked. (HOSTSERVER-529)

16.4.2 3.0.013.14 (2015-06-04)

- S3: Fixed bug in parsing S3 access log entries for traffic calculation (resolves Error getting spaceid errors in `td-hostserver.log`). Additionally, the S3 log analyser script now only downloads and processes objects from the log bucket that contain the string `access_log-`. (HOSTSERVER-500)
- `mod_pspace`: Added support for calculating traffic from S3-compatible object stores that do not support access logging via log buckets in the way that Amazon S3 does it. Now, if a redirect to S3 is performed and `S3LogBucketName` has not been specified, the request length will be logged as bytes sent. (HOSTSERVER-499)
- `s3d`: The S3 daemon has now been split into two processes, a worker process and a watchdog process. If the worker process dies, the watchdog will restart it. Killing the watchdog process will also kill the worker process. The watchdog will always try to restart the worker, but depending on the frequency with which the worker is dying the watchdog will wait before trying to restart it. The minimum wait is 3 seconds, the maximum is 30 minutes. (HOSTSERVER-508)

16.4.3 3.0.013.13 (2015-05-11)

- `mod_pspace/s3d`: Added workaround to handle a deviation in the Ceph 0.8 Object Store S3 API: the “list multipart upload parts” API request returns `ListMultipartUploadResult` instead of `listpartsresult` (see BUG#11494 in the Ceph bug tracker for details). (HOSTSERVER-484)
- `mod_pspace`: Added missing call to `s3d_delete()` when an “Upload to file that has already been transferred to S3” is detected. Due to the missing call, Clients could end up in an endless loop, showing a “wrong md5” error in the log file. (TDCLIENT-2045)
- `mod_pspace`: Added new module option `watched_space_id` that can be used to trace Client accesses to a specific Space for debugging purposes. See `tracing_client_accesses_to_a_single_space` for details. (HOSTSERVER-486)

16.4.4 3.0.013.12 (2015-04-14)

- `s3d`: Uploading the `last.log` file failed with a checksum error if the log was written to before the upload was complete. `s3d` now only transfers the data size used when calculating the checksum. This will allow the `last.log` file to grow while being uploaded to S3. (HOSTSERVER-474)
- `s3d`: Fixed unsafe object references during multi-part uploads which may have lead to `s3d` crashes. (HOSTSERVER-454)
- Installation: The `td-hostserver` RPM package will no longer reset the permissions and ownerships of the `/spacedata` and `/spacedata/vol01` directories to `700` and `apache:apache` during an update, if they had been changed by the administrator after the initial installation. Depending on how the Space Volume is mounted, the RPM installation could fail with an error like `error: unpacking of archive failed on file /spacedata`. A new installation will still create the directories using these permissions/ownerships by default. (HOSTSERVER-401)
- Host Server: Converted the type of the `StatisticRest` setting from `INT` to `DATE`, to avoid an error that could occur when updating from very old Host Server Versions (the `resetTraffic()` auto task failed with an `Invalid integer literal` error). This also fixes a potential issue that could result in the reset routine being run multiple times on the day the traffic is reset. (HOSTSERVER-478)

- Documentation: Fixed link structure in the HTML documentation so that clicking **Next** and **Previous** within a document works as expected. (HOSTSERVER-471)

16.4.5 3.0.013.11 (2015-03-30)

- Administration Console: Updated logo and favicon.
- Host Server: Updated some error messages by replacing “Repository” with “Depot”. Ensure that a Space Depot that has been marked as “Deleted” no longer allows the creation of new Spaces. (HOSTSERVER-456)
- mod_pspace: Reduced logging of errors by only logging Client accesses to deleted Spaces as an error if the Space status is zero. (HOSTSERVER-449)
- mod_pspace: Fixed a crashing bug that could occur in rare situations. (HOSTSERVER-457)
- s3d: Fix unsafe access to the thread pool that may have caused s3d to crash in certain situations. (HOSTSERVER-454)
- s3d: Fixed a problem that caused a crash if a multipart upload was interrupted before completion and then restarted again. The parts list could have holes in it for the parts that were successfully uploaded in the first try.
- Documentation: Added section that instructs the user to perform a `yum update` after installing the VM image. Reformatted the 3.0.013 release notes and replaced the table with regular sections for improved readability.
- Documentation: Added Failover and Scalability chapter to the Administration Guide, added description of the startup sequence/dependencies to the Installation Guides. (HOSTSERVER-431)

16.4.6 3.0.013.10 (2015-01-26)

- s3d: Fixed a problem that caused a crash from time to time. The crash would occur if a request for an object’s header timed out or was interrupted.
- Host Server: Fixed bug in the calculation of `DiskUsed` for Space Volumes that did not contain any Spaces. (HOSTSERVER-452)
- Administration Console: The Volume repair button now only appears if a repair is actually required (previously it appeared whenever there was an error on the volume).
- Installation: added a new RPM package `td-hostserver-doc-html` that contains the Host Server documentation in HTML format, installed in the Host Server’s Apache document root `/var/www/html/td-hostserver-doc/`. Access to the documentation can be restricted by editing `/etc/httpd/conf.d/td-hostserver-doc.httpd.conf`. (HOSTSERVER-450)
- Installation: fixed bug in upgrading from older versions and the `hostapilog` database did not get created. (HOSTSERVER-446)

16.4.7 3.0.013.9 (2015-01-14)

- mod_pspace/s3d: fixed unexpected object `"vol01/..."` starting with `'vol'` was found in the `bucket...` error, which prevented the Apache module from starting. This error could occur after updating from a previous version if S3 was already enabled, and the old object format (prefixed by volume name) was used on an S3 compatible object store. (HOSTSERVER-447)

16.4.8 3.0.013.8 (2015-01-13)

- API: Added missing `activatedepot` API command and added new tag `<changeinfo>` to add a free form comment to the change history of the following API commands: `activatedepot`,

`assignusertodepot`, `createdepotwithoutuser`, `deactivatedepot`, `deletedepot`. Updated API version to 3.0.004. (HOSTSERVER-337)

- Installation: fixed typo in the installation script that adds the RewriteRules to `ssl.conf`. Added RewriteRule in preparation for accepting Client requests for Space data via SSL/TLS (not supported yet).
- Installation: the binary tarball distribution now includes debug versions of the Host Server binaries (`s3d-debug` and `tshts-debug`) and Apache module (`mod_pspace-debug.so`, to better support analyzing possible crashing bugs. (HOSTSERVER-445)
- Installation: fixed possible upgrade error from previous versions: moving the MySQL table `pbpg.Keys` to the `pspace` database failed if an empty `pspace.Keys` table already existed. (HOSTSERVER-441)

16.4.9 3.0.013.7 (2014-12-12)

- Fixed error in creating an index during the initial MySQL table creation (HOSTSERVER-440)

16.4.10 3.0.013.6 (2014-12-09)

- Installation: fixed possible upgrade error from 3.0.011 when the MySQL database `pbpg` still existed, but the `Keys` table was already moved to the `pspace` database (HOSTSERVER-427)
- Fixed bug in which failed Auto Tasks were not executed anymore (HOSTSERVER-407)
- `mod_pspace`: fixed possible crash when system settings are NULL (e.g. in an upgrade scenario from 3.0.011 to 3.0.013, when `httpd` was started before `yvvd` performed the required schema updates)
- `mod_pspace`: Fixed possible “Admin API: AES decode error- corruption detected” error when updating from older versions (timing issues could result in the generation of duplicate private keys) (HOSTSERVER-420, HOSTSERVER-422)
- Increased the size of the `S3Options` settings field from 200 to 2000 chars, to accommodate longer option strings required for certain OpenStack environments (HOSTSERVER-425)
- Installation: updated `RewriteRule` sets in the `httpd` configuration files (removed obsolete `/depot` rule, HOSTSERVER-424)

16.4.11 3.0.013.5 (2014-09-26)

- `mod_pspace`: fixed a Space corruption bug that could occur when updating from a previous Host Server version to version 3.0.013 and Space Volumes were using a non-standard naming scheme (not “volxxx”)
- Admin Console: added “Repair” button that allows performing an automatic repair of Volumes affected by the corruption bug. Clients will be notified to perform a Space Restore operation on affected Spaces.

16.4.12 3.0.013.4 (2014-09-18)

- Admin Console: fixed 404 errors when opening the Admin URL without a trailing slash (HOSTSERVER-398)
- Admin Console: the input focus is now automatically set to the password field (HOSTSERVER-392)
- `s3d`: Fixed bug in path deletion on S3: if the path ended with `/` it wasn't being deleted.
- `s3d`: exceptions are now logged in `/var/log/s3d.log`

16.4.13 3.0.013.3 (2014-09-05)

- `mod_pspace`: Replaced the previously used MD5 implementation with calls to the MD5 routines provided by OpenSSL (yielding a 70% performance improvement when calculating MD5 checksums on large files) (HOSTSERVER-355)
- `mod_pspace`: consolidated brand-specific settings into one place and disabled multi-part uploads for OpenStack
- `mod_pspace`: Fixed bug where failed uploads (resulting in MD5 checksum failures) would still be accounted for as bytes written in the Space usage statistics (HOSTSERVER-352)
- Fixed autotask `resetTraffic()` to properly reset the traffic for Spaces that had the `SPACE_TRAFFIC_FULL` status flag enabled. (HOSTSERVER-353)
- Installation: security enhancement: set `ServerTokens` to `Prod` and `ServerSignature` to `Off` in `httpd.conf` to disable displaying the Apache Server version and OS version in the HTTP headers and on error pages (HOSTSERVER-357)
- `mod_pspace`: Disabled unnecessary buffering of files fetched from S3 object store and passed back to the client. (HOSTSERVER-356)
- `tshs`: `add-s3-host` will ping the S3 service before actually adding the host details.
- Admin Console: security enhancement: don't display the version and build number on the login page and `https` redirection page (HOSTSERVER-359)
- Security enhancement: disabled unneeded HTTP methods in `td-hostserver.httpd.conf` (only allow GET, POST, PUT, disable HEAD, OPTIONS, TRACE) (HOSTSERVER-361)
- Virtual appliance security enhancement: set `ServerTokens` to `Prod` and `ServerSignature` to `Off` in `httpd.conf` to disable displaying the Apache Server version and OS version in the HTTP headers and on error pages (HOSTSERVER-357)

16.4.14 3.0.013.2 (2014-07-14)

- To avoid confusion, the S3-related configuration option `openStackAuthURL` was renamed to `openStackAuthPath`

16.4.15 3.0.013.1 (2014-07-11)

Host Server Version 3.0.013 is the next major release following after version 3.0.011 (Version 3.0.012 was an internal release that has not been published).

Version 3.0.013 contains the following features and notable differences to version 3.0.011:

- The TeamDrive Host Server installation can now be performed via RPM on Red Hat Enterprise Linux 6 and derivative distributions, which significantly improves the installation procedure and the process of applying updates.
- The initial setup and registration of a Host Server is now fully web-based. It's no longer necessary to provide a `hosting.txt` or `properties` file. Instead, all the required information can be entered in a web form.
- The entire Host Server configuration is now stored in the MySQL database. This includes configuration settings for S3 daemon and TSHS.
- The web-based TeamDrive Hosting Service Administration Console has been improved significantly, by simplifying the work flows for common administration tasks and fixing several usability issues.
- TSHS, the TeamDrive Scalable Hosting Storage and the TeamDrive S3 Daemon provide additional scalability options to expand the storage capabilities of a TeamDrive Hosting Service.
- It's now possible to generate a monthly report that contains detailed statistics about all existing Depots and Spaces within these depots, including the monthly traffic and disk usage.

- The Host Server no longer depends on the PrimeBase Application Environment. Instead, it now uses the Yvva Runtime Environment, which replaces the following components:
 - `mod_yvva` replaces `mod_pbas` for providing the web-based Administration Console and API. The stand-alone `pbas` instance is no longer required. As a consequence, the `pbur` MySQL database which was used by PBAS to manage user accounts and privileges is no longer required and has been removed.
 - `yvvad` replaces `pbac` for running background tasks. The former `p1_autotask` background task PBAC instance is now provided by the service `td-hostserver`, which uses `yvvad`.
 - `yvva` replaces `pbac` for command line operations that involve executing PBT code on the shell.
- The installation location of the TeamDrive PBT code has been changed from `/home/teamdrive/pbas` to `/opt/teamdrive/hostserver/`.
- The `sakgen` binary that used to be installed in `/home/teamdrive/sakh` is no longer required. Instead, the functionality to encrypt Space Depot access keys is now provided by the `tshs` binary.
- All TeamDrive Host Server processes now run under the user ID used by the Apache http Server (`apache`). A dedicated `teamdrive` user account is no longer required.
- By default, the MySQL databases are now installed in the default location `/var/lib/mysql` instead of `/spacedb`, which made it difficult to enable SELinux on the MySQL instance.
- For security reasons, the MySQL credentials required for accessing the MySQL Database are no longer stored in the default MySQL configuration file `/etc/my.cnf`. Instead, the `[p1db]` options group has now been moved into a dedicated configuration file `/etc/td-hostserver.my.cnf`, only readable by the `apache` user.
- The Apache `httpd` Server configuration file has been renamed from `teamdrive.conf` to `td-hostserver.httpd.conf`.
- The overall robustness of the TeamDrive Host Server has been improved by issuing more meaningful error messages and performing more safety and consistency checks.
- Each Space Volume now contains a file `teamdrive-volume-id` that contains a unique global volume ID, to ensure that multiple volumes are mounted to the correct location.

16.5 Change Log - Version 3.0.011

16.5.1 3.0.011.6 (YYYY-MM-DD)

- HOSTSERVER-228: Add settings for `ClientPollFrequency` and `StatisticPollFactor`
- HOSTSERVER-241: Moved `[p1db]` group from `my.cnf` to a dedicated configuration file `/etc/td-hostserver.my.cnf` to improve security and packaging.

16.5.2 3.0.011.5 (2014-04-22)

- HOSTSERVER-224: Added `SpaceStatisticEnabled` and `SpaceStatisticExportPath`
- Updated `teamdrive.conf` Apache configuration file: wrapped long lines and updated `s3daemon` file locations to match the defaults suggested in the Installation Manual
- HOSTSERVER-191: Fixed Magic Username problem with `sakgen` by enclosing them with single quotes to avoid the shell from expanding them as variables. Fixed “bad file descriptor error”

16.5.3 3.0.011.4 (2014-03-12)

- Fixed HOSTSERVER-99: created database migration script `mysql/v3.0.010_to_v3.0.011.sql` to update the table structures, move the Keys table from database `pbpg` to `pspace` and renamed database `td2apilog` to `hostapilog`.
- Removed default `API_SALT` in sql script.
- Improved `hosting.txt` value validation.

16.5.4 3.0.011.3 (2014-03-03)

- Updated version number in `pbstab` from “4546” to “4547”
- Fixed HOSTSERVER-172: The default MySQL table definition file `mysql/plspace_schema.sql` contained a wrong value for the configuration variable `PathToSAKConverter`. Instead of `/home/teamdrive/sakh/sakgen` it should have been `/home/teamdrive/sakh/`.

16.5.5 3.0.011.2 (2014-02-07)

- Updated sample `hosting.txt` file: no trailing slash after `REGSERVERURL`
- Updated and completed Translation files (grammar, typos, obsolete terms)
- Set `PathToSAKConverter` configuration variable to `/home/teamdrive/sakh/sakgen` by default
- Added S3Daemon config and script files to the installation package
- Fixes to object store access log processing

16.5.6 3.0.011.1 (2014-02-04)

- Added parsing and error handling for `API_IP_LIST` and `API_SALT` from the `hosting.txt`.
- `pbstab`: changed log file from `/home/teamdrive/pbas/setup/pbac.log` to `/var/log/pl_autotask.log` (HOSTSERVER-145)
- `pbstab`: fixed wrong path to `plctl.dal`
- Fixed setting space status bit
- Fixed autotask debug output
- Fixed typos and obsolete reference to `plctl` from the translation files
- Changed configuration variable 340 “Protocol Log File” in `pbas.env` from “<< Default Log >>” to “`/var/log/pbas.log`” - note that this file needs to be created and assigned to the user running the PBAS instance (`touch /var/log/pbas.log ; chown teamdrive:teamdrive /var/log/pbas.log`)
- Fixed HOSTSERVER-150: removed reference to `td2apilog` database

16.5.7 3.0.011.0 (2014-01-28)

- First build of the 3.0.011 branch, using the scripted build