



**TEAMDRIVE**

**TeamDrive Host Server  
Administration**

*Release 4.0.3.0*

**Paul McCullagh, Eckhard Pruehs**

2022



<b>1</b>	<b>Copyright Notice</b>	<b>1</b>
<b>2</b>	<b>Trademark Notice</b>	<b>3</b>
<b>3</b>	<b>Introduction</b>	<b>5</b>
<b>4</b>	<b>TeamDrive Hosting Service Administration</b>	<b>7</b>
4.1	Host Servers (Hosts)	7
4.2	Volumes	8
4.3	Configuring the Storage Upgrade URL	9
4.4	Disabling the Apache Access Log	10
4.5	Changing an Admin User's Password	10
4.6	Enabling Two-Factor Authentication for Superusers	14
4.7	Changing the MySQL Database Connection Information	16
4.8	Manually creating a Depot	16
4.9	Increasing Volume Storage Space	16
4.10	Optional Configuration Settings	18
4.11	Customizing HTML templates for published files	19
<b>5</b>	<b>Hosting Service Management</b>	<b>21</b>
5.1	Managing Admin User Accounts	21
5.2	Managing Auto Tasks	22
<b>6</b>	<b>Backups and Monitoring</b>	<b>27</b>
6.1	Host Server Backup Considerations	27
6.2	Restoring individual Spaces or Volumes	28
6.3	Setting up Server Monitoring	32
<b>7</b>	<b>Host Server Failover Considerations and Scenarios</b>	<b>35</b>
7.1	Scaling a TeamDrive Host Server Setup	35
7.2	Host Server Failure Scenarios	36
7.3	Host Server Failover Test Plan	38
<b>8</b>	<b>Snapshot Backup and Point-in-Time Recovery</b>	<b>43</b>
8.1	Snapshot Backups	43
8.2	Snapshot Consolidation	44
8.3	Restoring a Snapshot	44
8.4	Cleanup File Data	45
<b>9</b>	<b>Depot Overflow and Automatic Space Reduction</b>	<b>47</b>
9.1	Depot Overflow	47
9.2	Related Settings	48
9.3	Email Notifications	48
<b>10</b>	<b>Setting up an Amazon S3/Azure BLOB Storage/Ceph Object Storage-Compatible Object Store</b>	<b>51</b>
10.1	Configuring s3d	51

10.2	Starting and Stopping the <code>s3d</code> service . . . . .	53
10.3	Optional configuration parameters . . . . .	53
10.4	OpenStack configuration parameters . . . . .	54
10.5	Enabling Object Store Traffic Usage Processing . . . . .	54
<b>11</b>	<b>TeamDrive Scalable Hosting Storage</b>	<b>57</b>
11.1	TSHS and Object Storage . . . . .	57
11.2	The <code>tshs</code> Command Line Tool . . . . .	60
11.3	Creating a TSHS-based TeamDrive Hosting Service . . . . .	60
11.4	Initializing a TSHS Cluster . . . . .	61
11.5	Creating a Storage Node . . . . .	61
11.6	Upgrading to TSHS . . . . .	62
11.7	Scaling Out the Cluster . . . . .	63
11.8	Connecting TSHS to an S3 Compatible Object Store . . . . .	64
11.9	Running Maintenance Tasks . . . . .	65
<b>12</b>	<b>Upgrading the TeamDrive Host Server</b>	<b>69</b>
12.1	General Upgrade Notes . . . . .	69
12.2	In-place Upgrading Version 3.6 to a Newer Build . . . . .	69
12.3	In-place Upgrading from 3.0.013 or 3.5 to 3.6 . . . . .	70
12.4	Migrating an Older Host Server Version to a 3.6 Instance . . . . .	73
<b>13</b>	<b>Troubleshooting</b>	<b>75</b>
13.1	List of relevant configuration files . . . . .	75
13.2	List of relevant log files . . . . .	75
13.3	Enable Logging with Syslog . . . . .	76
13.4	Tracing Client Accesses to a Single Space . . . . .	77
13.5	Common errors . . . . .	78
<b>14</b>	<b>Release Notes - Version 4.x</b>	<b>83</b>
14.1	Change Log - Version 4.0 . . . . .	83
<b>15</b>	<b>Release Notes - Version 3.x</b>	<b>87</b>
15.1	Change Log - Version 3.7 . . . . .	87
15.2	Change Log - Version 3.6 . . . . .	91
15.3	Change Log - Version 3.5 . . . . .	93
15.4	Change Log - Version 3.0.013 . . . . .	99
15.5	Change Log - Version 3.0.011 . . . . .	103
<b>16</b>	<b>Appendix</b>	<b>105</b>
16.1	Abbreviations . . . . .	105

## COPYRIGHT NOTICE

Copyright © 2014-2022, TeamDrive Systems GmbH. All rights reserved.

**TeamDrive Systems GmbH**

<https://www.teamdrive.com>

Max-Brauer-Allee 50

22765 Hamburg, Germany

Email: [info@teamdrive.com](mailto:info@teamdrive.com)



## TRADEMARK NOTICE

Linux is the registered trademark of Linus Torvalds in the U.S. and other countries.

Apache HTTP Server, Apache, and the Apache feather logo are trademarks of The Apache Software Foundation.

MySQL is a registered trademark of Oracle and/or its affiliates.

Intel and Intel Xeon are trademarks or registered trademarks of Intel Corporation.

AMD, Opteron, the AMD logo, and the AMD Opteron logo are trademarks or registered trademarks of Advanced Micro Devices.

VMware is a trademark or registered trademark of VMware, Inc. in the United States and/or other jurisdictions.

“Amazon Web Services”, “Amazon S3” are trademarks of Amazon.com, Inc. or its affiliates in the United States and/or other countries.

“Azure” is a trademarks of Microsoft Corporation.

“Red Hat Linux” and “CentOS” are trademarks of Red Hat, Inc. in the U.S. and other countries.

All other names and trademarks used herein are the property of their respective owners.





## INTRODUCTION

This document will guide you through the administration and advanced configuration of a TeamDrive Host Server. When managing the TeamDrive Hosting Service, we assume that you have basic knowledge of:

- **Linux system administration:**
  - Adding/configuring software packages
  - Editing configurations files
  - Creating user accounts
  - Assigning file ownerships and privileges
  - Creating and mounting file systems
  - Setting up environment variables
- Apache Web Server: installation and configuration, adding and enabling modules, modifying configuration files
- MySQL Database: installation and configuration, administration/maintenance, using the MySQL command line client, basic SQL
- Basic knowledge of application server technology



## TEAMDRIVE HOSTING SERVICE ADMINISTRATION

### 4.1 Host Servers (Hosts)

#### 4.1.1 Overview

In the overview, you can display the Host Servers, the associated volumes, and some statistical values. The volumes change colour between green, yellow, and red depending on the percentage used.

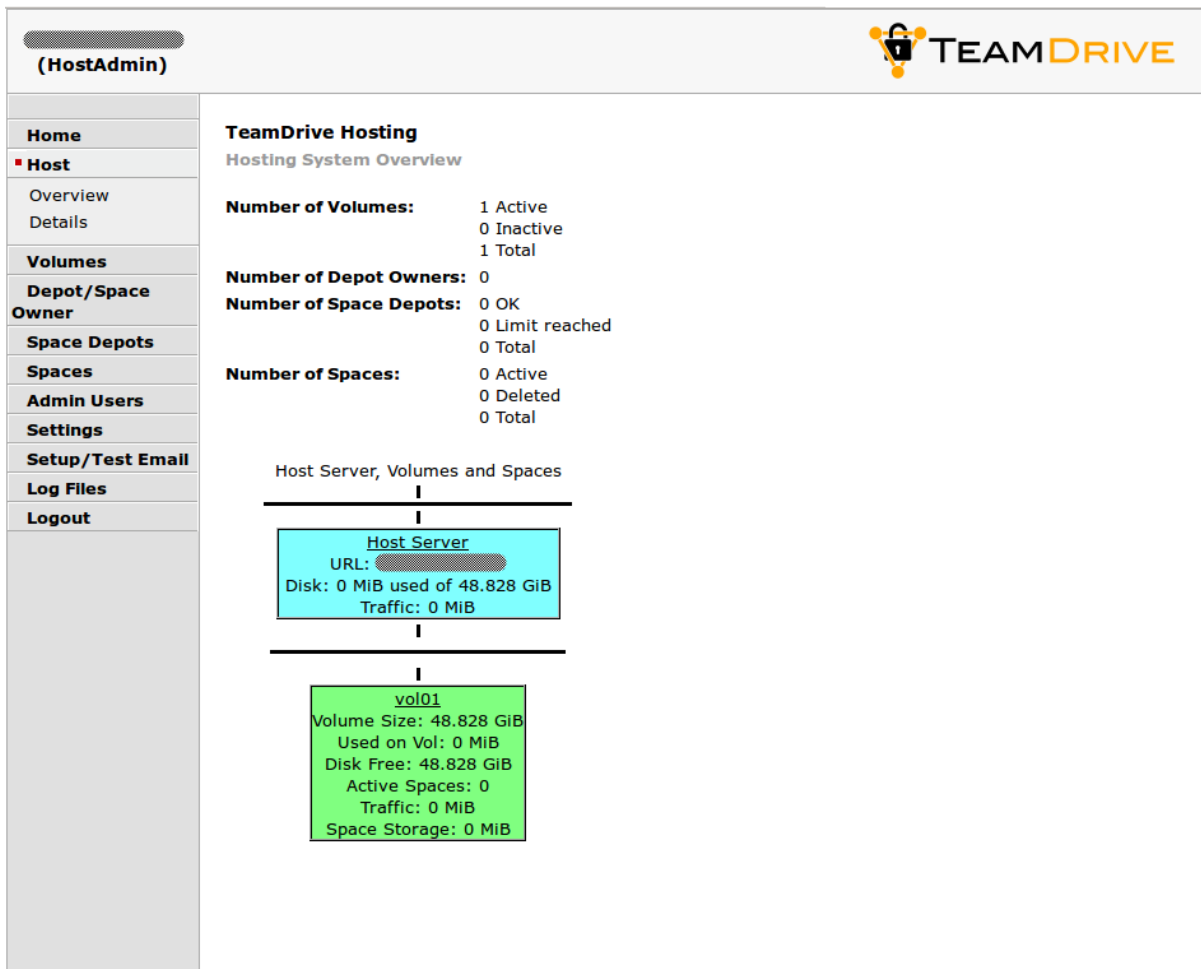

Fig. 4.1: Host Server Admin Console: Server Overview

The values are updated at regular intervals with the “SumUsage” background task. In the process, the associated Depot is updated via the Spaces, as are the volumes and hosts.

Volumes first appear in the view when created as described in the following chapter.

## 4.2 Volumes

### 4.2.1 Adding more Volumes

By default, the first volume `vol01` has already been created during the initial installation.

If you want to extend the storage space or distribute the load across multiple volumes, you can add more Space Volumes to a Host Server instance.

[notice] Existing spaces will stay on the volume on which they were created. In case of capacity problems, the best practice is to create a new bigger volume, copy all data from the old volume to the new volume and mount the new volume under the path of the old volume. Stop the `apache` and `td-hostserver` service during this step and don't forget to increase the volume size in the host admin volume menu afterwards, so that the host server knows the new volume usage size.

Prepare the additional volume, e.g. by creating a block device and file system as outlined in chapter *Storage Requirements* in the *TeamDrive Host Server Installation Guide*. Next, create a new mount point in the `/spacedata` directory, e.g. `/spacedata/vol02` and mount the volume.

The ownership of the volume must be assigned to the user that runs the Webserver (usually `apache`) using the `chown` command.

Also make sure the file system is properly mounted during system boot (e.g. by adding an entry to the system's `/etc/fstab` file).

To add the newly created Volume, log in to the Host Server Administration Console and click **Volumes** -> **Add New Volume** in the left navigation bar.

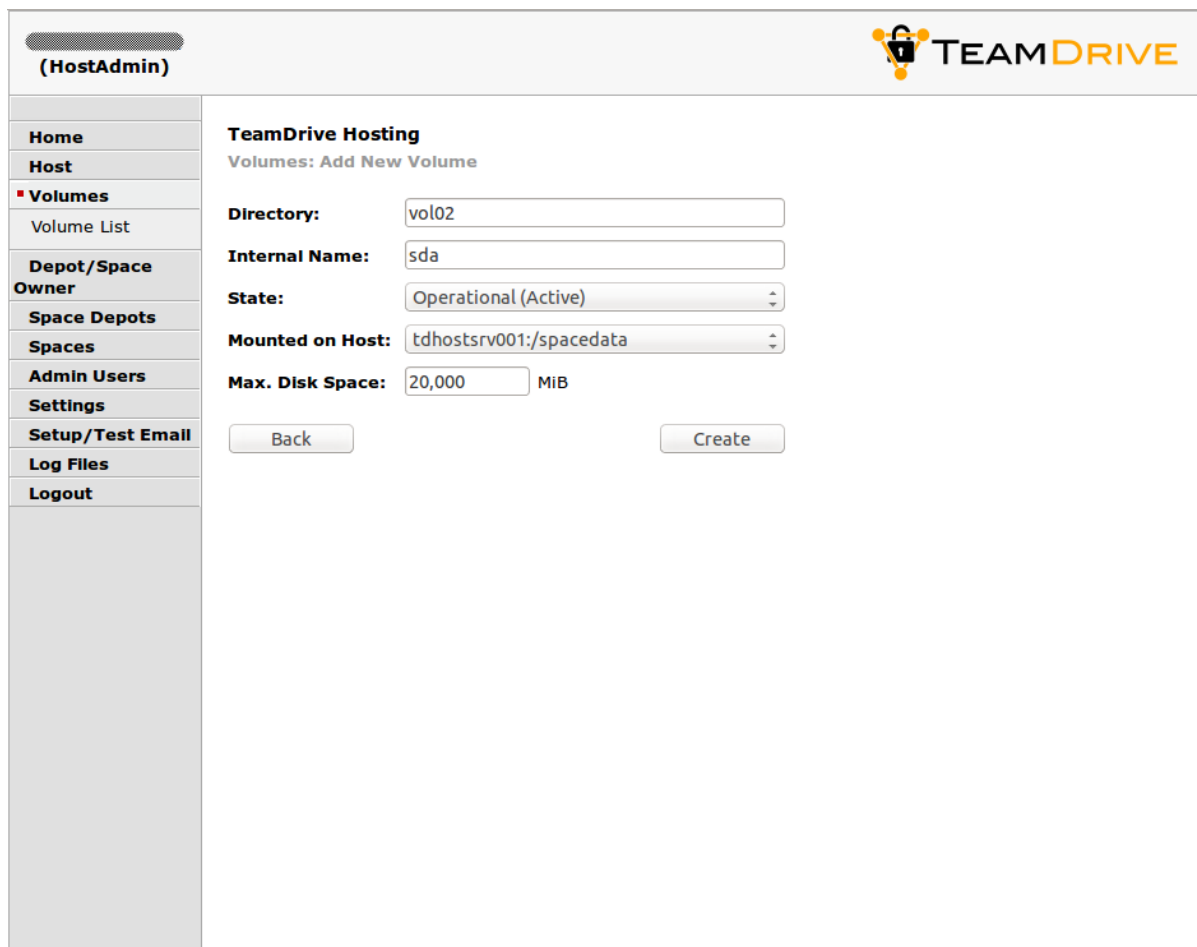

The screenshot shows the 'Add New Volume' form in the TeamDrive Host Server Administration Console. The interface includes a top navigation bar with the 'HostAdmin' label and the TeamDrive logo. A left sidebar contains a navigation menu with options: Home, Host, Volumes (selected), Volume List, Depot/Space Owner, Space Depots, Spaces, Admin Users, Settings, Setup/Test Email, Log Files, and Logout. The main content area is titled 'TeamDrive Hosting' and 'Volumes: Add New Volume'. It contains the following fields and controls:

- Directory:**
- Internal Name:**
- State:**
- Mounted on Host:**
- Max. Disk Space:**  MiB

At the bottom of the form are two buttons: 'Back' and 'Create'.

Fig. 4.2: Host Server Administration Console: Add New Volume

Enter the values as shown in the following example. Make sure to adjust them to match your configuration/environment.

Directory: **vol02** (this is the default and should be kept)

Internal Name: **sda**

State: **Operational (active)**

Mounted on Host: **tdhostsrv001:/spacedata**

Max. disk space (in MB): **20,000**

The field **Directory** defines both the Volume Name as well as the name of the mount point in the filesystem below the `/spacedata` directory.

---

**Note:** Volume names must be of the form: `vol1xx`, e.g. `vol101`, `vol102`.

Please don't use blanks in volume names.

The name of a volume cannot be changed later because it becomes part of the Space URL which the TeamDrive Clients use to access these spaces.

---

The field **Internal Name** is for your reference only, it could contain the name of the volume on your storage system or the local hard disk drive name or partition.

Click **Create** to create the new volume.

## 4.3 Configuring the Storage Upgrade URL

**Storage upgrade:** The server informs the TeamDrive Clients how much storage space and traffic is used per Space or account. The Space owner can reserve storage space via the TeamDrive Client and the TeamDrive Clients will generate an URL that opens in the browser. The URL always points to the Hosting Service. This request can be forwarded as required via a rewrite statement.

Open the file `/etc/httpd/conf.d/td-hostserver.httpd.conf` in an editor and ensure the following configuration option matches your environment.

Please replace in the Rewrite-Rule “`bestellung.hostserver.com`” with the URL pointing to your own server that provides information about how to upgrade storage. If a user clicks on the “More Storage” button in the TeamDrive Client, the client will open the URL specified.

Using the Rewrite-Rule allows you to redirect these requests to a custom web page where you can offer storage upgrade options:

```
# This Rewrite is required for the storage-upgrade-buttons
# in the TD-Client (see storage-upgrade-note in the documentation)
RewriteRule ^/upgrade/([a-z][a-z])/order.html(.*) \
https://bestellung.hostserver.com/$1/order.php$2 [R,NE]
```

The URL called by the client is structured as follows:

```
http://<domain-name>/upgrade/<2-character-language-code>/order.html
```

Examples of language codes are: `en` (English), `de` (German) and `fr` (French).

Additionally, the following values are provided by the TeamDrive Client as URL parameters:

- **spaceid:** The Space ID of the Space
- **host:** The host name (host name and Space ID together are always unique)
- **user:** The TeamDrive user name (BASE64-encoded)

- **check:** Checksum used to verify whether the request is valid

This allows you to create an order page according to your requirements and adapt it to your own needs (payment link). However, this page must always be present so that the user does not see an error message or an empty page.

Information about Spaces and Accounts can be retrieved from the Hosting Service via the Hosting Service API (an HTTP based interface which uses XML-formatted requests and replies). Please consult the TeamDrive Hosting Service Reference Guide for details.

Functions to delete Spaces and increase Storage limits after payment, for example, are also available. Please contact [support@teamdrive.net](mailto:support@teamdrive.net) if you need assistance in using this API.

## 4.4 Disabling the Apache Access Log

In view of the amount of requests issued by the TeamDrive Clients, there is no point in keeping the normal access log activated. We therefore suggest to deactivate it in a production environment. Only the error log should be left enabled. To facilitate this, comment out the following line in the default `httpd.conf`:

```
# CustomLog logs/access_log combined
```

If problems occur in a Space, logging can be activated for a specific Space (see [http://httpd.apache.org/docs/2.2/mod/mod\\_log\\_config.html](http://httpd.apache.org/docs/2.2/mod/mod_log_config.html)). e.g. all access to Space ID 3204 will be logged (the required Apache logging module needs to be enabled again):

```
SetEnvIf Request_URI 3204 spaceid-3204
CustomLog logs/spaceid-3204-requests.log common env=spaceid-3204
```

Restart the Apache instance and check the log files for errors.

## 4.5 Changing an Admin User's Password

The Host Server Administration Console can be accessed by all Admin Users by entering the correct username and password.

An existing user with administrative privileges can change his password directly via the Administration Console's login page or via the **Admin Users** page of the Administration Console.

On the login page, click on **Change Password...** to enable two input fields **New Password** and **Repeat Password** that allow you to enter the new password twice (to ensure you did not mistype it by accident). You also need to enter your username in the **Username** field and the current password in the **Password:** field above. Click **Login and Change Password** to apply the new password and log in.

You can also change your password while being logged into the Administration Console. If your user account has "Superuser" privileges, you can change the password of any admin user, not just your own one.

Click **Admin Users** to open the user administration page.

The page will list all existing user accounts and their details.

Click the username of the account you want to modify. This will bring up the user's details page.

To change the password, enter the new password into the input fields **New Password** and **Repeat Password** and click **Save** to commit the change.

The new password will be required the next time this user logs into the Administration Console.

In case you lost or forgot the password for the last user with Superuser privileges (e.g. the default `HostAdmin` user), you need to reset the password by removing the current hashed password stored in the MySQL Database (Column `Password`, located in Table `pspace.LocalUser`). This can be performed using the following SQL query.

Log into the MySQL database using the `teamdrive` user and the corresponding database password:

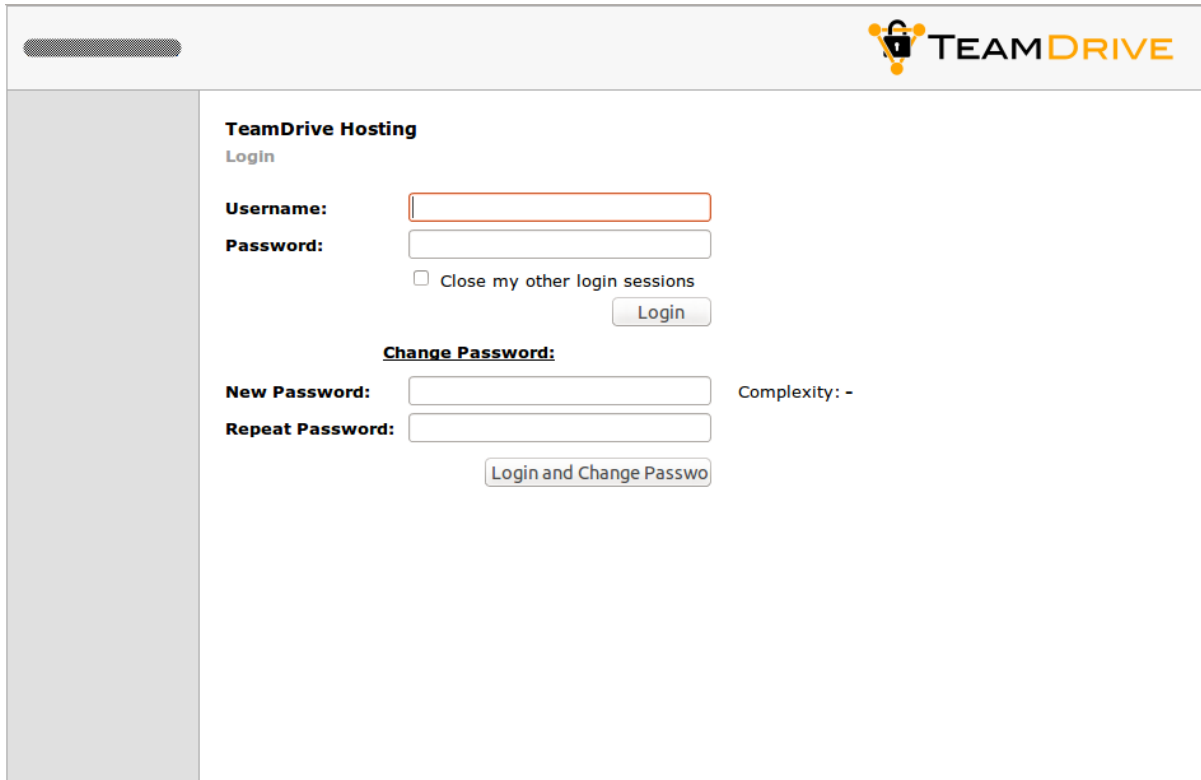

The screenshot shows the TeamDrive Host Server Administration Console. At the top right is the TeamDrive logo. The main content area is titled "TeamDrive Hosting" and contains a "Login" section with fields for "Username:" and "Password:", a checkbox for "Close my other login sessions", and a "Login" button. Below this is a "Change Password:" section with fields for "New Password:" and "Repeat Password:", a "Complexity: -" indicator, and a "Login and Change Password" button.

Fig. 4.3: Host Server Administration Console: Change Password

```
[root@hostserver ~]# mysql -u teamdrive -p
Enter password:

[...]

mysql> use pspace;
Database changed

mysql> SELECT * FROM LocalUser WHERE UserName='HostAdmin'\G
***** 1. row *****
      ID: 1
      Status: 0
      UserName: HostAdmin
      Email: your.name@yourdomain.net
      Password: $2y$10$s0mTNsotNx2Nq4s013zjDOVnWO6Qx.Lbw1zwcU3efKSXJPB9HGpzO
      ExtReference: NULL
      Privileges: Superuser
      CreationTime: 2015-05-18 10:56:54
      LastLoginTime: 2015-05-19 14:21:42
1 row in set (0.00 sec)

mysql> UPDATE LocalUser SET Password='' WHERE UserName='HostAdmin';
Query OK, 1 row affected (0.01 sec)
Rows matched: 1  Changed: 1  Warnings: 0

mysql> quit
Bye
```

Now you can enter a new password for the HostAdmin user via the login page as outlined above, by clicking the **Change Password** link, but leaving the **Password** field empty and only entering the new password twice, followed by clicking the **Login and Change Password** button.

(HostAdmin)



- Home
- Host
- Volumes
- Depot/Space Owner
- Space Depots
- Spaces
- Admin Users
- Admin Users List
- Add New Admin User
- Settings
- Setup/Test Email
- Log Files
- Auto Tasks
- Logout

### TeamDrive Hosting

Admin Users: List

ID	Username	Email	Privileges	External Reference	Last Login
1	HostAdmin	[REDACTED]	Superuser		2015-05-19 15:34:09
2	AdminUser	[REDACTED]	Administrator		2015-05-19 14:51:16

<< 1 >>

Fig. 4.4: Host Server Administration Console: Admin Users List



(HostAdmin)

- Home
- Host
- Volumes
- Depot/Space Owner
- Space Depots
- Spaces
- Admin Users**
- Admin Users List
- Settings
- Setup/Test Email
- Log Files
- Auto Tasks
- Logout

### TeamDrive Hosting

Admin Users: Details

**ID:** 2

**Creation Time:** 2015-05-19 14:19:20

**Status:**

**Username:** AdminUser

**New Password:**  Complexity: -

**Repeat Password:**

**Email:**

**External Reference:**

**Privileges:**

**Last Login Time:** 2015-05-19 14:51:16

Fig. 4.5: Host Server Administration Console: User Details

## 4.6 Enabling Two-Factor Authentication for Superusers

Starting with Host Server version 3.5, the Administration Console supports two-factor authentication via email. In this mode, an Admin User with “Superuser” privileges that wants to log in with his user name and password needs to provide an additional authentication code that will be sent to him via email during the login process. This feature is disabled by default.

The TeamDrive Host Server needs to be configured to send out these authentication email messages via SMTP. The Host Server is only capable of sending out email using plain SMTP via TCP port 25 to a local or remote MTA.

If your remote MTA requires some form of encryption or authentication, you need to set up a local MTA that acts as a relay. See chapter *Installing the Postfix MTA* in the *TeamDrive Host Server Installation Guide* for details.

Before you can enable two-factor authentication, you need to set up and verify the Host Server’s email configuration. This can be accomplished via the Host Server’s Administration Console. You need to log in with a user account having “Superuser” privileges in order to conclude this step.

Click **Setup / Test Email** to open the server’s email configuration page.

The screenshot shows the TeamDrive Host Server Administration Console interface. At the top left, the user is identified as '(HostAdmin)'. The top right features the TeamDrive logo. A sidebar on the left contains navigation links: Home, Host, Volumes, Depot/Space Owner, Space Depots, Spaces, Admin Users, Settings, Setup/Test Email (highlighted with a red box), Log Files, Auto Tasks, and Logout. The main content area is titled 'TeamDrive Hosting' and 'Email Setup / Test'. It contains several configuration fields, each with an information icon (i) to its right:

- SMTP Server:** localhost
- Send Timeout (seconds):** 5
- Sender Email Address:** postmaster@yourdomain.com
- Reply-To Email Address:** noreply@yourdomain.com
- Email Sending Host:** hostserver.yourcomain.com
- Email Address:** administrator@yourdomain.com

At the bottom right of the configuration area, there is a button labeled 'Send Test Email'.

Fig. 4.6: Host Server Admin Console: Email Setup / Test

Fill out the fields to match your local environment:

**SMTP Server:** The host name of the SMTP server accepting outgoing email via plain SMTP. Choose `localhost` if you have set up a local relay server.

**Send Timout:** The timeout (in seconds) that the mail sending code should wait for a delivery confirmation from the remote MTA.

**Sender Email Address:** The email address used as the Sender email address during the SMTP delivery, e.g. `postmaster@yourdomain.com`. This address is also known as the “envelope address” and must be a

valid email address that can accept SMTP-related messages (e.g. bounce messages).

**Reply-To Email Address:** The email address used as the “From:” header in outgoing email messages. Depending on your requirements, this can simply be a “noreply” address, or an email address for your ticket system, e.g. support@yourdomain.com.

**Email Sending Host:** The host name used in the HELO SMTP command, usually your Host Server’s fully qualified domain name.

**Email Address:** The primary administrator’s email address. This address is the default recipient for all emails that don’t have an explicit receiving address. During the email setup process, a confirmation email will be sent to this address.

After you’ve entered the appropriate values, click **Send Test Email** to verify the email setup. If there is any communication error with the configured MTA, an error message will be printed. Check your configuration and the MTA’s log files (e.g. /var/log/maillog of the local Postfix instance) for hints.

If the configuration is correct and functional, a confirmation email will be delivered to the email address you provided. It contains an URL that you need to click in order to commit your configuration changes. After clicking the URL, you will see a web page that confirms your changes.

This concludes the basic email configuration of the Host Server. Now you can enable the two-factor authentication by clicking **Settings** -> **Authentication** -> **UseTwoFactorAuth**. Change the setting’s value from `False` to `True` and click **Save** to apply the modification.

The screenshot shows the TeamDrive Admin Console interface. At the top right is the TeamDrive logo. On the left is a navigation menu with items like Home, Host, Volumes, Depot/Space Owner, Space Depots, Spaces, Admin Users, Settings (highlighted with a red box), Settings List, Setup/Test Email, Log Files, Auto Tasks, and Logout. The main content area is titled 'TeamDrive Hosting' and 'Settings: Details'. It shows a configuration for 'UseTwoFactorAuth' with a 'Name' field containing 'UseTwoFactorAuth' and a 'Value' field with radio buttons for 'True' (selected and highlighted with a red box) and 'False'. Below the radio buttons are 'Back' and 'Save' buttons. An information icon and text below the settings state: 'UseTwoFactorAuth: Set to True to enable 2-Factor Authentication for Superusers.'

Fig. 4.7: Host Server Admin Console: Use Two Factor Authentication

Now two-factor authentication for the Administration Console has been enabled.

The next time you log in as a user with “Superuser” privileges, entering the username and password will ask you to enter a random secret code, which will be sent to you via email to the email address associated with your

administrator account. Enter the code provided into the input field **Authentication Code** to conclude the login process.

## 4.7 Changing the MySQL Database Connection Information

The Host Server Apache modules `mod_pspace` and `mod_yvva` as well as the `yvvad` daemon that performs the `td-hostserver` background tasks need to be able to communicate with the MySQL management database of the Host Server.

If you want to change the password of the `teamdrive` user or move the MySQL database to a different host, the following changes need to be performed.

To change the MySQL login credentials, edit the file `/etc/td-hostserver.my.cnf`. The password for the `teamdrive` MySQL user in the `[p1db]` AND `[tshs]` option group must match the one you defined earlier:

```
[p1db]
database=pspace
user=teamdrive
password=<password>
host=localhost
socket=/var/lib/mysql/mysql.sock
```

If the MySQL database is located on a different host, make sure to modify the `host` variable as well, providing the host name or IP address of the host that provides the MySQL service. If required, the TCP port can be changed from the default port (3306) to any other value by adding a `port=<port>` option.

## 4.8 Manually creating a Depot

The default Depot is always linked to a single user. Using the Host Server Admin Console, it is possible to create Depots that are not linked to a particular user. Each TeamDrive Client that has a Depot file can create Spaces within it. A Depot must always be assigned to a TeamDrive user when it is created via the Web Interface. This is the Depot owner, and only they can later expand the storage space from their TeamDrive Client by using the upgrade button.

To set up a new Depot, click **Space Depots -> Add New Depot** in the navigation bar.

Fill out the fields based on the requirements for this Depot.

**Owner:** Click **Edit** to select a user from the selection list to which the Depot will be assigned. Use the **Selection Filter** input field to search for a specific username after clicking the **Apply** button. Click the desired username and click **OK** to finish the selection.

**Space Depot Name:** Any name can be selected for the Space Depot name. The name appears in the TeamDrive Client in the list of available Depots.

**Contract:** An account number used as a reference for other systems.

**Max. Disk Space and Traffic Limit:** These values should be set up at a ratio of at least 1:10 because users invite each other to the Spaces and the traffic thus may always be higher than the storage space used.

Click **Create** to create the Depot.

By clicking the **Depot Access File** link in the Depot Details screen, you can download the respective Depot file, which can be imported into the TeamDrive Client.

## 4.9 Increasing Volume Storage Space

The first scaling strategy is to add additional volumes to increase the available storage capacity. You should consider adding more volumes (or increase the size of a volume), if any existing volume reaches 60% of utilization.

Fig. 4.8: Host Server Admin Console: Add New Depot

Fig. 4.9: Host Server Admin Console: New Depot Owner Selection

For additional scaling, we recommend to add an object store which will scale unlimited. We offer additional tools for moving local data to the object store. An extended apache module will redirect client requests to the data that was moved to the object store. The clients could read the data directly from the object store, if it supports the HTTP protocol.

Please contact [sales@teamdrive.com](mailto:sales@teamdrive.com) for supported object stores.

## 4.10 Optional Configuration Settings

In the settings you can set up configurations, such as the IP address of the external server needed for the XML invocations referred to into access the account on the Hosting Service and automatically upgrade the storage space, if needed (after payment is received). Only requests from this IP are then accepted.

### 4.10.1 Using HTTPS for publishing files

TeamDrive can publish files so that they can be accessed without using a TeamDrive Client. The default protocol for uploading and downloading the data is HTTPS. This requires Apache to be appropriately configured and a valid SSL certificate must be installed. If security of published files is not an issue you can set the system parameter `HttpsUsedByPublish` to `False`.

### 4.10.2 Enabling storing Space Names

Each created Space will be stored on the Hosting Service. This record has different information such as: user, account, status and usage information and also the original Space title. For security reasons, the storing the Space names on the server is disabled by default. To enable storing the Space names: look for a boolean setting named `StoreSpaceNames` and set the value to `true`.

### 4.10.3 API return Space Names

By default, Space names will not be returned in the API for security reasons. To enable returning Space names: add a boolean setting with the name `APIReturnSpaceNames` and set the value to `true` (this setting will have no effect, if you disable `StoreSpaceNames` as described above).

### 4.10.4 Using HTTPS for the Admin Console

HTTPS is used by default to access the web-based Host Server Admin Console. For this reason the Apache HTTP Server must be configured to support SSL and a valid certificate installed. If the Admin Console is only accessed behind the firewall, then you can allow HTTP access by setting the system setting `HttpsUsedByAdmin` to `False`.

### 4.10.5 Reporting Usage Statistics

It's possible to generate a monthly report that contains detailed statistics about all existing Depots and Spaces within these depots, including the monthly traffic and disk usage. The report is prepared in the form of an XML file `statistic_from_MM_DD_YYYY_to_MM_DD_YYYY.xml` by `td-hostserver-task` at the beginning of each month. To enable the generation of these statistics, you need to change the Host Server setting `SpaceStatisticEnabled` from `False` to `True`. The resulting report files will be written to the path defined in `SpaceStatisticExportPath`.

## 4.10.6 External Traffic

The Hosting Service can store data externally (e.g., Amazon S3 storage, Azure BLOB storage). Outsourcing and directly accessing the client on external storage also generates external traffic. This is recorded separately and added to the direct traffic for the Depot. For transparency, this is displayed separately in the Web Interface. However, the value is only visible if the required module is used. The summarized value of the external traffic and the traffic directly to the host is provided to the TeamDrive Client.

## 4.11 Customizing HTML templates for published files

The new functionality to restrict access to published files using a password, requires a HTML page where the user enters a password. A set of default pages are included in the Host Server distribution, and are located in:

`/opt/teamdrive/hostserver/setup/templates/default`

You may add additional folders with customised templates in various languages. Each set of templates must be placed in an appropriately named directory, for example “en” for English and “de” for German. The Host Server uses the HTTP header information of the browser to detect the which language template to return.

If the browser specifies an unknown language, the server will return the template specified by the `DefaultLanguage` setting.

The following default templates are included:

**decryption-failed.html (added with version 3.7.5)** This page is returned if the public file was uploaded encrypted and the key from the URL can't decrypt the file.

**enter-password.html** Template for entering a password to access a password protected published file.

**exception.html** A general error page.

**file-not-found.html** Error page in case of the published file could not be found.

**invalid-url.html** This page is returned if the user enters an invalid public file URL, or if the URL has expired.

**password-wrong.html** Invalid password error page.

**public-redirect.html** A redirect page for accessing published files. See the description in the Release Notes for Version 3.5 about this security enhancement.

**upload-incomplete.html (added with version 3.7.5)** This page is returned if a public file is still in upload. This is necessary because, in the case of large files, the TeamDrive Client may make the public URL available before the upload is complete.





## HOSTING SERVICE MANAGEMENT

This chapter covers a number of common tasks that you may want to or need to perform with the Host Server.

### 5.1 Managing Admin User Accounts

The Admin Console of the Host Server allows you to creating additional Admin user accounts for managing the Host Server. Initially only one user account exists. This is the account you created when installing the Hosting Service.

There are 2 privilege levels:

- **Superuser:** Superuser's have unlimited access to the Host Server.
- **Administrator:** Administrator's have some limitations as to the operations they are able to perform.

Normally Administrator privileges are sufficient for managing the Host Server. A Superuser account is only required to perform certain configuration tasks, this includes:

- Creation of new user accounts
- Change user privileges
- Configure external authentication for user accounts
- Setup of email configuration
- Setup of 2-factor authentication

The Superuser also specifies the maximum rows that can be view in the Admin Console user interface. Limiting the number of rows ensures that Administrators cannot view all data, they need to have more specific information about what they wish to view.

#### 5.1.1 External Authentication

When using external authentication for Admin user account, credentials are located on an external authentication system, such as LDAP or Active Directory.

In this case, you must provide the Host Server with a URL that will be used to verify login, and retrieve user account information. This value is specified using the `ExtAuthURL` system setting.

When an user of an external account successfully logs in for the first time an account is automatically created for the user in the host Server. Future login for the user nevertheless requires confirmation by the external login service. The user `External Reference` is used to uniquely identify the user on both systems.

#### 5.1.2 Securing the Admin Console

It is recommend that you carefully restrict access to the Admin Console. For Superuser accounts, you can activate 2-factor authentication which sends an authorisation email to a user to confirm access.

Apache itself offers further possibilities for limiting and controlling access. Using a RewriteCond you can limit access to certain fixed IP numbers. mod\_authz\_host (also known as mod\_access) can be used to specify an IP address range (or subnet).

HTTPS access to the Admin Console should be required. In order to simply setup of a Host Server, SSL access is not required during the installation phase.

However, it is recommended that you configure your server to use a valid SSL certificate as soon as possible. Once you have done this, set the system setting `HttpsUsedByAdmin` to `True` to ensure that the Admin Console can only be accessed using HTTPS.

## 5.2 Managing Auto Tasks

There is a number of background jobs, called “Auto Tasks”, that are being performed by the Yvva-based `td-hostserver` service.

The behaviour of the Auto Tasks are controlled by the various settings available for each task.

The overall frequency of how often the background service will wake up can be changed by modifying the setting `repeat` in file `/etc/td-hostserver.conf`. The default value is 10 seconds.

Note that the frequency of the individual tasks can be defined differently. If the extent can be modified depends on the task settings. The tasks status, last run time and last execution result can be seen in the Host Server Admin Console:

**(HostAdmin)**

**TeamDrive Hosting**  
**Auto Tasks: List**  
**Services:**  
**td-hostserver:** yvvad (pid 28970) is running... ([td-hostserver.log](#))  
**s3d:** s3d (pid 21760) is running... ([s3d.log](#))

Name	Status	Frequency	Last Run Time	Last Result
<a href="#">Check Spaces with Limit</a>	Active	5m	4 Minutes ago	OK
<a href="#">Cleanup API Log</a>	Active	24h	22.6 Hours ago	OK
<a href="#">Cleanup File Data</a>	Active	5m	59 Seconds ago	OK
<a href="#">Close Sessions</a>	Active	5m	4 Minutes ago	OK
<a href="#">Consolidate Snapshots</a>	Active	7h	1.5 Hours ago	OK
<a href="#">Create Snapshots</a>	Active	5m	59 Seconds ago	OK
<a href="#">Delete Public Files</a>	Active	30m	21 Minutes ago	OK
<a href="#">Delete Read Notifications</a>	Active	5m	59 Seconds ago	OK
<a href="#">Delete Snapshots</a>	Active	5m	59 Seconds ago	OK
<a href="#">Delete Space</a>	Active	5m	4 Minutes ago	OK
<a href="#">Process S3 Logs</a>	Active	10m	10 Minutes ago	OK
<a href="#">Reset Traffic</a>	Active	5m	4 Minutes ago	OK
<a href="#">Sum Disk Usage</a>	Active	5m	4 Minutes ago	OK
<a href="#">Sync Owner Data</a>	Active	30m	19 Minutes ago	OK
<a href="#">Volume Warning</a>	Active	5m	4 Minutes ago	OK

For the snapshot functionality it’s important, that the `td-hostserver` background task is always running. The above `Auto Task` page will show the status and process id. In case of using an object store, the `s3d` service is

necessary for the `Cleanup File Data` task to clean up the files located on the object store. If no object store is used, the process information for the `s3d` service will not be displayed.

### 5.2.1 Check Spaces with Limit Task

This task compares the current traffic total and disk usage to the traffic and disk limit set for a Depot. If any of these limits are exceeded the task sets the appropriate status flags for all Spaces in the Depot.

As long as they are set, the status flags prevent any further upload of data to the Spaces in the Depot.

If, after files are deleted in a Space, the disk limit is no longer exceeded, this task will remove the status flag for disk usage so that upload may continue.

If the traffic limit is exceeded, then the traffic limit status flag remains set until the end of the month (see “Reset Traffic Task” below).

This task runs every 5 minutes.

### 5.2.2 Cleanup API Log Task

This task removes old entries in the API log. The `APILogEntryTimeout` (see `apilogentrytimeout`) specifies how old, in days, a log entry must be before it is removed. If no value or zero is specified, then this task does not execute.

This task runs every 24 hours.

### 5.2.3 Cleanup File Data Task

This “Cleanup File Data task” deletes files and versions that are no longer reference by a Space. This process is usually performed after restoring a Snapshot, and is initiated by the TeamDrive Client.

See *Cleanup File Data* (page 45) for details.

This task runs every 5 minutes.

### 5.2.4 Close Sessions Task

This task deletes TeamDrive Protocol v2 (TDPv2) sessions after a certain amount of idle time. The sessions are created by the TeamDrive Clients in order to upload data to the Host Server. If a session is removed, the client will automatically create a new session.

This task is not required for TeamDrive Protocol v3, which uses a signature-based authentication method that does not require session handling.

This task runs every 5 minutes.

### 5.2.5 Consolidate Snapshots Task

This task consolidates a number of Snapshots into a single Snapshot after a certain amount of time. This is done to reduce the number of Snapshots per Space.

See *Snapshot Consolidation* (page 44) for details.

This task runs once every 7 hours.

## 5.2.6 Create Snapshots Task

This task creates snapshot backups of Spaces according to the specified Snapshot Frequency of the Space. Snapshots must be enabled for the Space.

A Snapshot is a backup at a specific point in time, that allows a restore to this point in time. See *Snapshot Backups* (page 43) for details.

This task runs every 5 minutes.

## 5.2.7 Process Download Log

This task deletes Download Log entries that are older than the `DownloadLogRetention` period (see `downloadlogretention`).

If the download limit is exceeded this task sends a notification email to all System Administrators that have been specified to receive notifications.

The email includes a list of the depots (maximum 10) in which the limit event occurred. This email is sent at most once per hour.

## 5.2.8 Delete Expired Resources Task

Certain resources used by the TeamDrive client have an expiry time, after which point they are deleted.

This includes:

- **Read Notification:** A read notification indicates that certain files have been read or opened by a user.
- **Soft Locks:** These are locks placed by the TeamDrive client on files that have been opened by users.

This task runs every 5 minutes.

## 5.2.9 Delete Public Files Task

A TeamDrive Client that uploads a public file may specify an expiry date. This task removes public files that have expired.

This task runs every 30 minutes.

## 5.2.10 Delete Snapshots Task

This task deletes Snapshot Backups that have expired because they have reached the Maximum Snapshot Age or because Snapshot Backups have been disabled for the Space.

When a snapshot is removed, the data (deleted files and versions) that is associated with the backup is also removed. See *Snapshot Backups* (page 43) for more details.

## 5.2.11 Delete Space Task

Spaces that are deleted, either by the TeamDrive Client, or on the Admin Console are marked for deletion. The delete operation is then performed by this task.

The task removes all files associated with a Space, this includes the removal of data from the external S3-compatible Object Store if necessary.

Once all the data of a Space has been removed, the Space is marked as deleted, and is no longer visible in the Admin Console. Set the `ShowDeletedObjects` (see `showdeletedobjects`) setting to `True` in order to see previously deleted Spaces.

This task runs every 10 minutes.

### 5.2.12 Process S3 Logs Task

This task records network traffic used by TeamDrive Clients access the S3-compatible Object Store directly. This is done by downloading and scanning the access logs created by Object Store. For this to work, the `S3LogBucketName` must be specified (see `s3logbucketname`).

See the section *Enabling Object Store Traffic Usage Processing* (page 54) in the Host Server Administration Guide for further details.

This task runs every 5 minutes.

### 5.2.13 Recalculate Space Size Task

Normally, disk usage of a depot is calculated on the fly by the hosting server. However, since the Host Server database and the file system are not transactionally connected it is possible that size usage indicated does not exactly reflect the actual usage.

If this is suspected, then a recalculation of disk usage can be scheduled manually on the Admin Console. A size recalculation is also scheduled automatically after a space is restored, and when a depot exceeds the disk usage limit.

This task performs size recalculation in the background. It does this by summing up the local disk usage and the sizes of files stored in the Object Store (if an Object Store is in use).

Since space activity may occur during size recalculation, transfers to the Object Store are suspended during this time.

This task runs once every minute, in order to check if any activity is required.

### 5.2.14 Reduce Disk Usage Task

This task checks to see if any depots have exceeded the usage limit. If so, the task sends warning emails to the owners and managers of the depot before it deletes spaces in order to reduce usage below 100% of the threshold.

The exact procedure followed by this task is described here: *Depot Overflow and Automatic Space Reduction* (page 47).

This task runs every 10 minutes.

### 5.2.15 Reset Traffic Task

At the beginning of each month the traffic used per Depot is reset to zero. If the Depot traffic limit was exceeded, then this task removes the associated status flag from all Spaces in the Depot. This signals the TeamDrive Clients that upload of data may continue.

If the `SpaceStatisticEnabled` configuration setting is set to `True`, a monthly report containing detailed statistics like monthly traffic and disk usage for all existing Depots and Spaces within these depots will be created. See the section *Reporting Usage Statistics* (page 18) in the Host Server Administration Guide for details.

### 5.2.16 Sum Disk Usage Task

When the TeamDrive Client accesses a Space, the bytes transferred over the network and the amount of data written to disk are recorded in a log entry.

This task sums the accumulated network traffic log entries per Space and Depot, and the disk usage per Space, Depot and Volume.

This task runs every 5 minutes.

### 5.2.17 Sync Owner Data Task

This task retrieves the up-to-date information about all Depot/Space Users from the Registration Server, this includes the Registration Server on which the user is registered and the user's email address. When known, this information is displayed in the Owner Details view.

By default the task will run once every 30 minutes, and checks the details of up to 50 Owners per run. This ensures that updates to Owner's email address will be propagated to the Host Server within 24 hours, if there are less than 2400 Owners on the Host Server.

### 5.2.18 Volume Warning Task

This task sends an email notification if volume usage exceeds predefined thresholds. The thresholds are specified using the `NotifyVolumeWarningLevel` (`notifyvolumewarninglevel`) and `NotifyVolumeCriticalLevel` (`notifyvolumecriticallevel`) settings.

The setting `NotifyVolumeEmail` (`notifyvolumeemail`) is used to specify the email address for the notification. In addition to this, the email configuration for the Hosting Service must be setup. How to do this is explained in the section: *Enabling Two-Factor Authentication for Superusers* (page 14).

## BACKUPS AND MONITORING

### 6.1 Host Server Backup Considerations

The two most important assets of a TeamDrive Host Server are the storage volumes that host the actual TeamDrive Spaces as well as the MySQL database that stores the related meta data.

The backup schedule depends on the amount of users, their activity and your recovery point objective. We recommend to run a backup at least once a day. The backups should be safely stored on another system.

Ideally, the time and frequency of the Host Server backup should be synchronized with the backup schedule used on the associated Registration Server — this ensures that the information about Users and their Space Depots is consistent across these systems.

In a virtualized environment, the usage of VM snapshots is highly recommended, as these provide atomic and instant full-system copies across multiple instances that can be backed up offline.

The backup of the Host Server's Space Volume(s) can be performed by any given file system backup tool.

When planning a backup of the volume containing the TeamDrive Spaces, keep in mind that the `last.log` files, located in each Space directory in the directory `protocolog` are frequently updated by the TeamDrive Clients. New space data and events are constantly appended to the file. When the log files reach a certain size (currently set to 8MB, but this value is not fixed and could change in later versions of TeamDrive), they get renamed and new `last.log` files will be created. This operation is initiated by the Clients. The naming scheme is to rename `last.log` to `<number>.log`, where `<number>` is the next free number, starting from 0. Previously renamed log files are not modified anymore, but must remain available to the clients since these logs must be read when a Space is joined.

To create a consistent backup, the best approach is to perform a snapshot of the entire Space Volume file system, preferably after shutting down the Apache http Server beforehand. If you are using an incremental backup method like `rsync`, keep in mind that some Spaces may have been changed while the `rsync` job is still running. For consistency, we suggest to perform a full `rsync` run while the service is running (to sync the bulk of the changes), then briefly change the volume's status to **Standby** or shut down the Apache HTTP Server and run `rsync` once more, to transfer the remaining changes that have occurred in the meanwhile. Once the `rsync` job has finished, the Apache HTTP Server can be started again.

The MySQL databases must also be backed up periodically, ideally at the same time the Space Volume(s) are being backed up. This ensures a consistent snapshot of the file system and the related meta data included in the MySQL database.

The Host Server's MySQL databases that need to be backed up are named `pspace` and (optionally) `hostapilog`. They use MySQL's InnoDB storage engine to provide transaction support, fast recovery and consistency. Any of the usual MySQL backup methods may be used, e.g. `mysqldump`. The size of the Host Server's MySQL Databases is usually quite small, if API logging is not enabled.

The MySQL backup can be performed using any established MySQL backup method, e.g. running a `mysqldump` via a cron job, or using more sophisticated tools like Percona XtraBackup or Oracle's MySQL Enterprise Backup. Other commercial backup solutions usually offer MySQL-specific plugins or extensions as well.

An example MySQL backup job using `mysqldump` could look like as follows. The SQL dump is piped through `gzip` for compression before it is written to a directory `/backup`, using a time stamp for the file name:

```
[root@regserver ~]# mysqldump -u root -p --single-transaction \  
--databases pspace hostapilog \  
| gzip > /backup/td-hostserver-mysql-$(date +%Y-%m-%d_%H.%M).sql.gz
```

See the MySQL documentation at <https://dev.mysql.com/doc/refman/5.1/en/backup-and-recovery.html> for more details and hints on how to define a MySQL backup strategy.

If the I/O overhead introduced by running the backup job on the production database is a concern, we recommend setting up a MySQL replication slave on another host and use this one to perform the backup. This second MySQL instance can also function as a hot standby server for high-availability purposes.

More details about MySQL replication and high availability can be found in the MySQL reference manual at <https://dev.mysql.com/doc/refman/5.1/en/replication.html> and <https://dev.mysql.com/doc/refman/5.1/en/ha-overview.html>.

In addition to the Space Volumes and MySQL databases, we recommend to create backup copies of the Server's configuration files. Please refer to the *TeamDrive Host Server Installation Guide* for details on the relevant configuration files.

These files should be backed up at least every time you changed them. These backups can be performed using any file-based backup method, e.g. using `tar`, `rsync` or more sophisticated backup tools, e.g. Amanda or Bacula.

## 6.2 Restoring individual Spaces or Volumes

---

**Note:** The Host Server 3.7 supports Snapshot Backups and Point-in-Time (PIT) Recovery. If snapshots are enabled the users are able to do a restore to a previous date of the space by themselves. A restore on the Hosting Server is only necessary if spaces were deleted or data got corrupted or lost for a space or a volume (for Snapshot Backups and Point-in-Time (PIT) Recovery see *Snapshot Backup and Point-in-Time Recovery* (page 43)).

---

In case of corrupted or lost data of a single Space or complete Volume, it is possible to restore the Space or Volume data from a previously created backup.

An example scenario would be a Space that was entirely deleted by a user by accident, or the recovery of a file that was moved to the Space's Trash Folder and the Trash was then emptied.

---

**Note:** Note that it is not possible to restore an individual file from a particular Space on the Host Server — due to the client-side encryption it's impossible to determine the correct file on the server side. However it is possible to restore the entire **state** of a Space and all of its files to a previous version, which will allow the user to extract the missing file(s) on the client side.

An additional challenge is identifying the Space(s) you want to restore; by default, Space names are not stored on the Host Server and are only referenced by their ID. Take extra caution and double check you're working on the correct Space.

---

The process of restoring a Space or Volume involves the following steps:

1. Identify the ID of the Space or Volume you want to restore.
2. Deactivate the Space or all Spaces of a Volume by setting the “Deactivated for restore” status, to prevent TeamDrive Clients from accessing the affected TeamDrive Spaces.
3. Restore the Space(s) by restoring the necessary Space directory or entire volume directory from your backup to the corresponding location.
4. Reactivate the Space(s) to make it/them available to the TeamDrive Clients again.
5. The Clients will be notified that a Space recovery is required, which should be performed according to the procedure outlined in the TeamDrive Client documentation.



If a restore of a single Space is required, the task of (de-)activating it can be performed via the Host Server's Administration Console. Open the Space Details page, check the **Deactivated for restore** checkbox and click **Save** to change the state.

After the restore has finished, click **Space Restored** to re-enable the Space.

The screenshot shows the 'TeamDrive Hosting' interface. On the left is a navigation menu with items like Home, Host, Volumes, Depot/Space Owner, Space Depots, Spaces, Admin Users, Settings, Setup/Test Email, Log Files, Auto Tasks, and Logout. The main content area is titled 'Spaces: Details' and shows information for a specific space (ID: 1). The 'Status' section has several checkboxes: 'Deactivated by provider', 'Deactivated by owner', 'Deactivated for maintenance', 'Deactivated for restore' (checked and highlighted), 'Volume storage full', 'Space Depot storage full', 'Traffic limit reached', and 'Read-only access'. Below this, there are fields for Owner, Space Depot (Depot-2), Volume (vol01), Used Storage (20 MIB), Traffic in May (20 MIB), Traffic Total (20 MIB), Created (2015-05-19 16:44:04), Last Access (2015-05-19 16:45:38), Last Update (2015-05-19 16:45:38), and Space URL. At the bottom, there are buttons for 'Back', 'Delete', 'Complete Restore' (highlighted), and 'Save'.

Fig. 6.1: Host Server Administration Console: Restore Space

Alternatively, the Space deactivation and reactivation can be performed on the command line (see below).

If you need to restore an entire volume, all Spaces contained in this volume need to be deactivated and reactivated. This done using commands provided by the `yvva` runtime commandline tool, as described below.

In any case, the actual task of restoring the Space(s) from backup has to be performed manually by the administrator and the TeamDrive Clients will have to perform a local Space recovery to get the local Spaces back into a consistent state.

## 6.2.1 Using the Restore Commands

The Restore Commands are executed using the Yvva Runtime Environment's commandline shell `yvva`:

```
[root@hostserver ~] yvva
Welcome to yvva shell (version 1.4.1).
Enter "go" or end the line with ';' to execute submitted code.
For a list of commands enter "help".

RESTORE COMMANDS:
-----
```

To get help on restore commands, enter:

```
restore_help;;  
>
```

Enter `restore_help;;` to get a list of commands that can be run:

```
> restore_help;;  
  
RESTORE COMMANDS:  
-----  
Before restoring a Volume or Space, you must run the deactivate function.  
This ensures that the Spaces are not accessible during restore. Then  
restore the Volume or Space, by copying your backup to the appropriate  
location. Once this is done, reactivate the Volume or Space.  
  
list_volumes;;  
  Print a list of Volumes  
  
list_spaces;;  
  Print a list of Spaces.  
  
deactivate_volume(vol_id);;  
  Deactivates all Spaces on a Volume.  
  
deactivate_space(space_id);;  
  Deactivates a Space.  
  
reactivate_volume(vol_id);;  
  Reactivates all Spaces on a Volume.  
  
reactivate_space(space_id);;  
  Reactivates a Space.
```

`vol_id` and `space_id` are the ID's of the Volumes and Spaces as displayed by `list_volumes` and `list_spaces` or shown in the Admin Console. These values must be placed in parenthesis as indicated. The functions are executed by ending the command with two consecutive semicolons.

Note that when you activate or deactivate a Volume, deleted Spaces are not affected. To reactivate a deleted Space, use `reactivate_space`.

## 6.2.2 Identify the Space you want to Restore

Usually, the ID of the Space to restore should be obtained from the TeamDrive Client. The **Space Information** displayed in the Client window for each Space contains a field **Space ID** that contains the ID used on the Host Server. The actual Space data will be stored in a subdirectory below the Space volume, using the Space ID as the directory name.

To list all available Spaces on the Hosting Service you can execute the command `list_spaces`:

```
> list_spaces;;  
  
-----  
| Spaces  
-----  
| Volume | ID      | Title                | ResID | Status |  
-----  
| vol01  | 3      |                      | 2     | 0     |  
| vol01  | 4      |                      | 3     | 0     |  
-----
```

A list of all active Spaces will be displayed which should look similar to the list shown above. Identify the ID of the Space you want to restore.

Note that Spaces will only have titles if the setting `StoreSpaceNames` is set to `true`.

### 6.2.3 Deactivate the Space to Restore

After identifying the Space you want to restore, you have to deactivate it by providing the ID to the command `deactivate_space(space_id)`:

```
> deactivate_space(3);;
160809 16:00:33 [Notice] Deactivate space [3]
160809 16:00:33 [Notice] Space: 3, deactivated
```

In the example above the Space with the ID '3' has been deactivated. After a short while, the Client will notice this change and mark the Space accordingly on its side.

### 6.2.4 Restore Backup

After deactivating a Space, you can now restore its data by copying the backup of that Space into the corresponding location on the Space volume, e.g. `/spacedata/vol01/3` in our case.

### 6.2.5 Reactivate Space

After copying the backup to the deactivated Space, you have to reactivate the Space which makes it available to the TeamDrive Clients again. To reactivate a certain Space you have to execute the command `reactivate_space(space_id)`:

```
> reactivate_space(3);;
160809 16:13:06 [Notice] Reactivate Space [3]
160809 16:13:06 [Notice] /spacedata/vol01/3
160809 16:13:06 [Notice] Space: 3, reactivation successful [Restore ID: 4, Log No: ↵
↵3, Log Offset: 1419]
```

In the example above the Space with the ID '3' has been reactivated.

The Client will now notify that the Space has been reactivated and a local Space recovery operation has to be performed, if necessary.

### 6.2.6 Identify the Volume you want to Restore

To identify all available volumes on the Hosting Service you have to execute the command `list_volumes`:

```
> list_volumes;;
-----
| Volumes                                     |
|-----|-----|-----|
| ID    | Name  | Status |
|-----|-----|-----|
| 1     | vol01 | Operational |
| 2     | vol02 | Operational |
|-----|-----|-----|
```

A list with the volumes will be displayed which should look similar to the list shown above. Identify the ID of the volume you want to restore.

## 6.2.7 Deactivate the Volume to Restore

After identifying the volume you want to restore, you have to deactivate the volume with all its Spaces. To deactivate a volume with a certain ID you have to execute the command `deactivate_volume(vol_id)`:

```
> deactivate_volume(1);;
160809 16:15:23 [Notice] Deactivate Volume [1]
160809 16:15:23 [Notice] Volume vol01: Spaces to deactivate: 3
160809 16:15:23 [Notice] Space: 62, deactivated
160809 16:15:23 [Notice] Space: 63, deactivated
160809 16:15:23 [Notice] Space: 64, deactivated
```

In the example above the volume with the ID '1' and all the spaces within that volume will be deactivated.

## 6.2.8 Restore Backup

After deactivating a volume, you can now restore its data by copying the backup of that volume into the corresponding location.

## 6.2.9 Reactivate Volume

After copying the backup to the deactivated Volume, you have to reactivate the Volume which makes the Spaces available to the TeamDrive Clients again. To reactivate a certain Volume you have to execute the command `reactivate_volume(vol_id)`:

```
> reactivate_volume(1);;
160809 16:16:55 [Notice] Reactivate Volume [2]
160809 16:16:55 [Notice] Reactivate Space [62]
160809 16:16:55 [Notice] /spacedata/vol01/62
160809 16:16:55 [Notice] Space: 62, reactivation successful [Restore ID: 5, Log No:
→ 0, Log Offset: 549]
160809 16:16:55 [Notice] Reactivate Space [63]
160809 16:16:55 [Notice] /spacedata/vol01/63
160809 16:16:55 [Notice] Space: 63, reactivation successful [Restore ID: 12, Log
→No: 2, Log Offset: 913]
160809 16:16:55 [Notice] Reactivate Space [64]
160809 16:16:55 [Notice] /spacedata/vol01/64
160809 16:16:55 [Notice] Space: 64, reactivation successful [Restore ID: 5, Log No:
→ 5, Log Offset: 4252]
```

In the example above all Spaces on the Volume with the ID '1' have been reactivated.

## 6.2.10 Exit the yvva session

You can close the `yvva` session by typing `quit` or pressing `Ctrl+D` on the `>` prompt.

## 6.3 Setting up Server Monitoring

It's highly recommended to set up some kind of system monitoring, to receive notifications in case of any critical conditions or failures.

Since the TeamDrive Host Server is based on standard Linux components like the Apache HTTP Server and the MySQL database, almost any system monitoring solution can be used to monitor the health of these services.

We recommend using Nagios or a derivative like Icinga or Centreon. Other well-established monitoring systems like Zabbix or Munin will also work. Most of these offer standard checks to monitor CPU usage, memory utilization, disk space (especially the file systems providing the TeamDrive Space Volumes) and other critical server parameters.

In addition to these basic system parameters, the existence and operational status of the following services/processes should be monitored:

- The MySQL Server (system process `mysqld`) is up and running and answering to SQL queries
- The Apache HTTP Server (`httpd`) is up and running and answering to http requests (this can be verified by accessing the files <http://hostserver.yourdomain.com/ping.xml> and <http://hostserver.yourdomain.com/admin/ping.xml>)
- The `td-hostserver` service is up and running (process name `yvvad`)
- For Host Servers using an compatible object store (see *Setting up an Amazon S3/Azure BLOB Storage/Ceph Object Storage-Compatible Object Store* (page 51) for details): the `s3d` process is up and running
- For Host Servers using TeamDrive Scalable Hosting Storage (TSHS, see *TeamDrive Scalable Hosting Storage* (page 57) for details): the `tshs` process is up and running (and all related MySQL nodes are up and running, too)



## HOST SERVER FAILOVER CONSIDERATIONS AND SCENARIOS

### 7.1 Scaling a TeamDrive Host Server Setup

A first step in increasing a single Host Server's performance would be to monitor and review the system's CPU, RAM and Disk I/O utilization, and to adjust the server configuration by adding more RAM/CPU's or increasing the storage bandwidth, if necessary (also called "scale-up strategy").

Adding more CPUs typically increases the maximum number of possible concurrent connections to the service and reduces the latency. However, the ability to handle more connections also requires more memory, as the system needs to spawn more concurrent Apache instances. So usually both parameters need to be adjusted.

Adding more RAM can also help to improve database and file system throughput and latency, as it allows the operating system and database to keep more of its working set and caches in memory, which enables it to return data quicker.

If your setup has reached the physical limits of a single server instance, you can further improve the scalability as well as the redundancy of a TeamDrive Host Server by implementing a "scale out" strategy.

In this setup, you distribute the load across several independent systems, by deploying multiple virtual or physical Apache server instances of the TeamDrive Host Server behind one or more load balancers.

This configuration also mitigates the risk of a service outage, e.g. if an instance fails or needs to be taken offline for maintenance purposes.

---

**Note:** The Host Server's Space Volumes must be placed on a shared storage medium like an NFSv4 server or shared disk file systems like OCFS2 or GFS2, as each Host Server instance requires concurrent access to the same Space Volume(s). As an alternative to shared storage, using a compatible object store (e.g. Amazon S3, OpenStack Swift or Azure BLOB storage) or the TeamDrive Scalable Hosting Storage (TSHS) can be utilized.

---

A migration from a single instance setup to such a scaled-out configuration can usually be performed with very little downtime, so you can start small and grow your setup as the need arises.

However, you must ensure that in case of a node failover/outage, the remaining nodes can handle the load that is usually distributed across all server instances.

---

**Note:** In a scale-out scenario, the Host Server's MySQL database server must be set up as a separate instance, so each Host Server node has access to the same data set.

---

To avoid the MySQL database to become a single point of failure, we recommend to set up MySQL in a redundant configuration, too (e.g. by using MySQL replication or other clustering technologies like Galera/Percona Cluster).

---

**Note:** The TeamDrive Host Server configuration does not support accessing more than one MySQL Server; you need to use a floating/virtual IP address that gets assigned to the currently active MySQL instance.

---

If you intend to run multiple independent Host Server instances (e.g. to serve a globally distributed user base), you can assign users to different Host Servers, e.g. by registering more than one Host Server to a given Provider, or using multiple Provider Codes on different Registration Servers.

These independent TeamDrive Host Server instances can then be scaled using the strategies above.

In a single instance configuration, a re-appearing server can suffer from a “thundering herd problem”, as a large number of TeamDrive Clients will try to synchronize their accumulated pending changes simultaneously. This can lead to a peak in the number of concurrent connections to this server, its MySQL database and storage subsystem, resulting in a noticeable increase in network and disk I/O.

This effect can be mitigated by temporarily extending the poll interval used by the Clients, increasing the number of Apache instances, or by temporarily assigning more resources like vCPUs or vRAM to a virtual machine.

The MySQL server’s configuration might also need to be reviewed in order to support more concurrent database connections.

## 7.2 Host Server Failure Scenarios

This chapter discusses most likely outages that can occur on a TeamDrive Host Server, if no additional redundancy is provided.

Chapter *Host Server Failover Test Plan* (page 38) outlines some possible tests you should perform, and what results to expect.

### 7.2.1 Entire Host Server Outage

An outage of the entire TeamDrive Host Server can be triggered by any of the following events:

- Failure of the entire Host Server host system (e.g. a hardware or OS crash/failure)
- Network failure that renders the Host Server unavailable
- Failure of the Host Server’s Apache HTTP Server
- Failure of the Host Server’s Space Volume storage system
- Failure of the Host Server’s MySQL Database
- Failure of the S3 compatible object store
- Failure of the TeamDrive Scalable Hosting Storage (TSHS)

In case of an outage of the entire TeamDrive Host Server, the TeamDrive Clients will mark any existing Spaces on that Host Server as “Offline”.

However, it is still possible to work with these Spaces locally; the Clients will record any local changes (e.g. adding or removing files, making modifications) and queue these events for later submission once the Host Server is available again.

The following Client operations can not be performed while the Host Server is unavailable:

- Creating new Spaces
- Publishing files
- Inviting users to existing Spaces

In addition to that, the following administrative operations via the Host Server’s API or Administration Console will not be possible:

- Creating new Space Depots via the API (e.g. using the Registration Server’s Administration Console)
- Changing the limits of existing Space Depots
- Assigning a default depot to a newly registered user upon first login



Except for the MySQL Server outage, this failure scenario can be avoided by setting up multiple instances of the Host Server behind a load balancer with failover capabilities and using a shared/scalable and redundant storage system for all nodes.

## 7.2.2 Space Volume Outage

The storage volume hosting the Space Volumes might become unavailable, e.g. because the mount point `/spacedata/vol01` is missing or empty due to a failed mount after a reboot, an outage of the NFS server or a network connection failure between the Host Server and the storage subsystem. The Host Server will notice the missing volume or Space data and log error messages to the Apache error log `/var/log/httpd/error_log`, e.g.:

```
[error] [client x.x.x.x] Unable to create space path: Possible Mount Error:
Volume Global ID required: "xxxxxxxxxxxxxxxxxxxxxxxxxxxxxxxx", but Space not
found: xx, path: /spacedata/vol01
```

or:

```
[error] [client 10.0.3.1] Space data root path missing: /spacedata/vol01
```

The Clients will receive a notification for Spaces hosted on that volume, indicating that the Space has been disabled for maintenance.

The Server will return to normal operation automatically, as soon as the missing volume is available again, re-enabling the affected Spaces on the Clients.

Increasing the availability of the storage subsystem can be performed in numerous ways and is highly dependent on the technology or vendor used. Consult the documentation of your storage technology for details/options.

## 7.2.3 MySQL Database Outage

A failure of the Host Server's MySQL Database could be triggered by one of the following events:

- Failure of the entire MySQL Server host system (e.g. a hardware or OS crash/failure)
- Network failure that renders the MySQL Server unavailable for the Host Server
- Failure of the MySQL Server's `mysqld` process

The failure will be indicated by error messages in the following Host Server log files.

`/var/log/td-hostserver.log`:

```
[Error] -12036 (2002): Can't connect to local MySQL server through socket
'/var/lib/mysql/mysql.sock' (2)
[Error] "startup.yv" (80)
```

`/var/log/mod_pspace.log`:

```
[Error] db_connect(pspace_mdb.c:318) Failed to connect to default group:
[pldb]
[Error] db_connect(pspace_mdb.c:318) MySQL Config file:
/etc/td-hostserver.my.cnf
[Error] pl_send_xml_response(mod_pspace.c:986) Space x: [HTTP 503] Status:
0 Error code: 0
```

To mitigate the risk of a MySQL Server outage, consider setting up a cluster of MySQL Servers, using MySQL replication, DRBD or other replication and HA technologies to provide synchronization and redundancy.

## 7.2.4 Outage of the `td-hostserver` Background Service

If the `td-hostserver` background service (process name `yvvad`) has failed or was not started at bootup time, regular Client operations are not affected immediately.

However, the following background tasks are no longer performed, which may lead to unwanted consequences over time:

- Spaces marked for deletion are no longer physically removed from the Space Volume's file system, which could lead to the file system filling up until it runs full.
- The disk usage of Volumes and Spaces is no longer calculated. Clients will not be notified if they have reached their storage limits.
- Monthly traffic statistics are not being reset at the end of the month. Clients that have exceeded their traffic in the meanwhile might be blocked from synchronizing Space data once the `td-hostserver` service has been re-enabled.

See chapter *Background Tasks Performed by ‘td-hostserver’* in the *TeamDrive Host Server Installation Guide* for further details on the individual tasks performed by this service.

Restarting the `td-hostserver` background service will pick up where the previous process has stopped.

For increased redundancy, it is possible to run this service on each TeamDrive Host Server instance in a multi-server installation.

## 7.3 Host Server Failover Test Plan

Based on the failover scenarios described in chapter *Host Server Failover Considerations and Scenarios* (page 35), the following tests should be performed to verify the correct behaviour and recovery from failures of individual TeamDrive Host Server components.

This test plan assumes an environment consisting of two virtualized TeamDrive Host Server instances (`hostsrv01` and `hostsrv02`), located behind a load balancer, using a shared NFSv4 share for storing the Space data and using a dedicated MySQL Server instance (`td-mysql`) for storing Space management information. Other setups/configurations may require additional tests, depending on the environment.

---

**Note:** Note that the configuration described above contains several components for which no redundancy is provided, therefore these components are considered single points of failure (SPOF). In particular, the following components can become a SPOF:

- The Host Server's Space Volume. In this scenario, the Space data coming from the TeamDrive Clients is stored on an NFS server. If the NFS share becomes corrupted or unavailable, the TeamDrive Clients will be unable to synchronize Space data with their peers until the file system has been restored or made available again.
  - The MySQL database instance (`td-mysql`). If this instance becomes unavailable, the entire TeamDrive service will be affected and rendered unavailable until the service is restored.
  - The load balancer/firewall. If the public-facing load balancer/firewall fails, the TeamDrive service will be unavailable.
- 

### 7.3.1 Single Host Server Instance Failure

An outage of one of the TeamDrive Host Server instances (`hostsrv01` or `hostsrv02`) should be simulated/triggered in the following ways:

- Shutting down the Apache HTTP Server running `service httpd stop`.
- Shutting down the network connection, e.g. by running `service network stop`, `ifconfig eth0 down` or by disconnecting the virtual network interface via the virtual machine management console.

- Shutting down the entire virtual machine e.g. via the virtual machine management console or by running `poweroff`.

Expected results:

- The load balancer should detect that the Host Server instance is no longer available and redirect any incoming traffic to the remaining instance instead. If configured, a notification about the outage should be sent out to the monitoring software.
- The monitoring software should raise an alert about the Host Server instance being unavailable, specifying the nature of the outage (e.g. `httpd` process missing, network unavailable, etc.).
- The remaining Host Server instance should handle all incoming Client requests. The TeamDrive Service should not be impacted/affected in any way.

Once the outage has been resolved and the instance has recovered, the following is expected to happen:

- The load balancer should detect that the Host Server instance is available again. Incoming traffic should be spread across both instances again.
- The monitoring software should detect the service recovery and perform the respective actions (e.g. resetting the alert, sending an update notification).
- The TeamDrive Service should continue unaffected throughout this process

### 7.3.2 Multiple Host Server Failures

An outage of **both** of the TeamDrive Host Server instances (`hostsrv01` and `hostsrv02`) should be simulated/triggered in the following ways:

- Shutting down the Apache HTTP Servers running `service httpd stop` on both instances.
- Shutting down the network connections, e.g. by running `service network stop,ifconfig eth0 down` on both instances, or by disconnecting the virtual network interfaces via the virtual machine management console.
- Shutting down the entire virtual machines e.g. via the virtual machine management console or by running `poweroff`.

Expected results:

- The load balancer should detect that the Host Server instances are no longer available and stop redirecting any incoming traffic to the instances. Incoming requests should be answered with an appropriate error code (HTTP error code 503 - Service Unavailable). If configured, a notification about the outage should be sent out to the monitoring software.
- The monitoring software should raise an alert about the Host Server instances being unavailable, specifying the nature of the outage (e.g. `httpd` process missing, network unavailable, etc.).
- The TeamDrive Service will be impacted/affected as outlined in chapter *Entire Host Server Outage* (page 36).

Once the outage has been resolved and at least one of the Host Server instances has been recovered, the following is expected to happen:

- The load balancer should detect that the Host Server instance is available again. Incoming traffic should be redirected to the instance and incoming requests should no longer result in HTTP errors.
- The monitoring software should detect the service recovery and perform the respective actions (e.g. resetting the alert, sending an update notification).
- Once the TeamDrive Clients have noticed the service being available again, operations should proceed as before.

### 7.3.3 Testing Space Volume Outage

An outage of the TeamDrive Host Server instance's Space Volume (NFS share) should be simulated/triggered in the following ways:

- Detaching/unmounting the NFS share from the Space Volume mount point, for example by temporarily shutting down the Apache HTTP Server and the Host Server background tasks and unmounting the volume, e.g. by running the following commands:

```
# service httpd stop
# service td-hostserver stop
# umount /spacedata/vol01
# service td-hostserver start
# service httpd start
```

- If technically possible, disconnecting NFS share from the virtual machine at run time, e.g. by detaching the network connection (by running `ifconfig <device> down` for the respective network interface, detaching the virtual network card from the virtual machine) or shutting down the NFS server. **Note that this operation may lead to data inconsistencies or file system corruption and should only be performed on non-critical test data.**

Expected results:

- The TeamDrive Host Server should detect the missing volume and react as outlined in chapter *Space Volume Outage* (page 37).
- The monitoring software should raise an alert about the missing volume.
- Optionally, the load balancer could be instructed to return an error (e.g. HTTP error code 503 - Service Unavailable), to fend off incoming Client requests until the outage has been resolved.

Once the outage has been resolved and the Space Volume has been mounted again, the following is expected to happen:

- The Clients should continue the Space synchronization at the point where they were interrupted by the outage. Incomplete Spaces will be restarted again. In case of a severe corruption of the Space Volume (e.g. file system errors), a restore from backup and a Space/Volume recovery might be required, as documented in the *Team Drive Host Server Administration Guide*.
- The monitoring software should detect the service recovery and perform the respective actions (e.g. resetting the alert, sending an update notification).
- If configured, the load balancer should be instructed to stop returning 503 Errors to Client requests (e.g. by the administrator).

### 7.3.4 Testing MySQL Server Failures

An outage of one of the MySQL Server instance (td-mysql) should be simulated/triggered in the following ways:

- Shutting down the MySQL Server by running `service mysqld stop`.
- Shutting down the network connection, e.g. by running `service network stop, ifconfig eth0 down` or by disconnecting the virtual network interface via the virtual machine management console.
- Shutting down the entire virtual machine e.g. via the virtual machine management console or by running `poweroff`.

Expected results:

- The TeamDrive Host Server instances will no longer be able to handle incoming Client requests as outlined in chapter *MySQL Database Outage* (page 37).
- The monitoring software should raise an alert about the MySQL Server instance being unavailable, specifying the nature of the outage (e.g. `mysqld` process missing, network unavailable, etc.).

Once the outage has been resolved and the MySQL Server is available again, the following is expected to happen:

- The TeamDrive Host Server instances will continue to operate where they were interrupted by the MySQL Server outage. The TeamDrive Clients will pick up where they left, synchronizing all accumulated/pending changes.
- The monitoring software should detect the service recovery and perform the respective actions (e.g. resetting the alert, sending an update notification).

### 7.3.5 Testing Load Balancer Failure

Since all TeamDrive instances are accessed through a load-balancer, an outage of this component should be tested as well:

- Shutting down the load balancer
- Removing the network connections to the TeamDrive Server components

Expected results:

- The TeamDrive Host Server instances will no longer be able to handle incoming Client or API requests as outlined in chapter *Entire Host Server Outage* (page 36).
- The monitoring software should raise an alert about the load balancer instance being unavailable, specifying the nature of the outage.

Once the outage has been resolved and the load balancer is available again, the following is expected to happen:

- The TeamDrive Host Server instances will continue to operate as soon as they receive incoming Client requests again. The TeamDrive Clients will pick up where they left, synchronizing all pending changes that have accumulated in the meanwhile.
- The monitoring software should detect the service recovery and perform the respective actions (e.g. resetting the alert, sending an update notification).



## SNAPSHOT BACKUP AND POINT-IN-TIME RECOVERY

The Host Server 3.7 supports Snapshot Backups and Point-in-Time (PIT) Recovery. PIT Recovery involves rolling back the complete state of a Space to a previous point in time. When this is done, all data (files and versions) and meta-data (for example, invited users and access rights) are restored to the state at the specified point in time.

In particular, all files that were deleted subsequently to the point in time, will be undeleted, and all changes to files after the point in time will be removed.

---

**Note:** Snapshot Backups are not a substitute for regular backups of the Host Server data. In other words, the Snapshot Backup functionality does not guarantee the durability of data on the Host Server. This must be assured by using an Object Store, RAID storage and/or other methods of guaranteeing data persistence (see *Backups and Monitoring* (page 27)).

---

The purpose of Snapshot Backups is to allow PIT recovery on the TeamDrive Client.

### 8.1 Snapshot Backups

In order to restore a Space to a previous point in time, Snapshot Backups must be enabled for the Space. When Snapshot Backups are enabled, the Host Server periodically makes a “Snapshot” of the state of a Space. This is done by the “Create Snapshots Task” (see *Create Snapshots Task* (page 24)).

A Snapshot contains the data required to restore a space to the point in time at which the Snapshot was made.

The storage requirement of a Snapshot is minimal and will be stored in the host server database, so frequent (for example, every 30 minutes) snapshots are possible. However, when Snapshot Backups are enabled, the files of the Space will not be actually deleted, although they will be reported as deleted by the TeamDrive Client. Deleted files are associated with a particular Snapshot, and are only removed when the Snapshot is deleted.

A maximum Snapshot age may be specified for a Space. Snapshots that reach this age are automatically deleted, and the associated deleted files as well.

Because file data is not deleted until the Snapshot Backup is deleted, the Space requires additional storage proportional to the maximum age of Snapshots in the Space.

#### 8.1.1 Enabling and Disabling Snapshots

Snapshot Backups are enabled at the Space level. This setting may be changed by the TeamDrive Client or in the Host Server Admin Console.

If not specified when creating a Space, the setting `EnableSnapshotsByDefault` determines whether Snapshot Backups are enabled for the Space or not (see `enablesnapshotsbydefault` for details).

When the global setting, `SnapshotsEnabled`, (see `snapshotsenabled`) is set to `False`, the Host Server will not create Snapshot Backups for any Spaces. This means that if `SnapshotsEnabled` is set to `False` then the Space level setting is ignored.

When Snapshot Backups are disabled at the Space level, all existing Snapshot Backups are deleted. This does not occur immediately, but is scheduled to be done in the background by the “Delete Snapshots Task” ( see [Delete Snapshots Task](#) (page 24))

Setting `SnapshotsEnabled` to `False` does not delete existing Snapshots.

### 8.1.2 Snapshot Settings

The Snapshot Backup frequency and the Maximum Snapshot Age are both set at the Space level. This can be done using the TeamDrive Client or the in the Host Server Admin Console.

If these values are not set, or are set to zero, at the Space level, then the global defaults apply (see `defaultsnapshotfrequency` and `defaultsnapshotmaximumage`, for details).

## 8.2 Snapshot Consolidation

Snapshots are automatically consolidated after a certain time. The process of consolidation combines several Snapshot Backups into one. Consolidation is performed in order to decrease the total number of Snapshots per Space.

By default, all Snapshots on a day are consolidated into a single Snapshot after 30 days, and all Snapshots in a month are consolidated into a single Snapshot after 365 days.

The first threshold of 30 days can be modified by changing the `ConsolidatePerDayAfter` global setting. The second threshold of 365 days can be modified by changing the `ConsolidatePerMonthAfter` setting (see `consolidateperdayafter` and `consolidatepermonthafter`).

Consolidation is done by the “Consolidate Snapshots Task” (see [Consolidate Snapshots Task](#) (page 23)).

## 8.3 Restoring a Snapshot

Restoring a Snapshot is initiated by the TeamDrive Client. When a user wishes to restore a Space to a previous point in time, the TeamDrive Client displays a list of available Snapshots specified by the time the Snapshot was made.

After the user selects a time, the TeamDrive Client “rewinds” the **local copy** of the Space to the specified point in time. The user can then check the contents of the Space to confirm if the correct point in time has been found. If necessary, the user can move forward or backward in time, depending on which other Snapshots are available.

During this process the local copy of the Space is in “read-only” mode. This means that data can be copied out of the Space, but no changes may be made to the Space.

When the user is satisfied with the selected Snapshot he/she may “commit” the Snapshot which causes the restore of the Space to the selected point in time to become permanent for all users. Alternatively the user can cancel the process and return the local copy of the Space to the present time.

---

**Note:** Once a Snapshot restore is committed a Space can no longer be returned to a later point in time. The data in the Space after the select recover point in time is no longer accessible and will be permanently deleted (see [Cleanup File Data](#) (page 45) below).

---

The restore process can be used to retrieve a previous copy of a file or directory in a Space. Since the restore process involves changes only to the local copy of the Space, if the restore is not committed, other users in the Space will not be effected in any way.

After a Snapshot restore has been committed, other users in the Space will be required to perform a Restore on the Space before they can continue using the Space. The TeamDrive Client indicates when a restore is pending for the Space.



## 8.4 Cleanup File Data

Cleanup File Data is a process that is triggered after a Snapshot restore. The process removes file data no longer referenced by a Space due to the restore. This process runs in the background, but may prevent a second Snapshot restore from being performed immediately after a previous restore. If this occurs you are required to wait until the Cleanup Process is complete.

The Cleanup Process is initiated by the TeamDrive Client that performed the Snapshot restore. Because the data of a Space is encrypted on the Host Server, the server cannot tell which files and versions are still in use after a restore. As a result, the TeamDrive Client builds a list of the data that is still in use and sends this to the server.

Once the server receives the list, the deletion process proceeds automatically in the background (see *Cleanup File Data Task* (page 23)) without any further client interaction. However, if the TeamDrive Client that performed the restore, is shutdown by the user before it can deliver the list of data in use, then Cleanup Process cannot be completed.

In this case unused file data on the server will not be deleted and the Space disk usage on the server will remain at an inflated level. In order to repair this situation it will be possible to initiate a Cleanup File Data process manually in a future version of the TeamDrive Client.



## DEPOT OVERFLOW AND AUTOMATIC SPACE REDUCTION

The Host Server 4.0 automatically deletes spaces in order to reduce the size of depots to the required limit. Before doing this, the server sends a series of emails to the user over the course of between 70 and 120 days.

In addition, spaces will **not** be deleted unless the depot of the space has been idle for over 60 days, and the settings described below are set to `True`.

Emails are sent to TeamDrive users are sent using a function provided by the Registration Server. For this purpose, Registration Server version 4.5 or later is required. If the Registration Server is not capable of sending emails, the deletion process will not proceed.

The emails are sent to the owner of the depot and, if the depot belongs to an account, then all managers of the account also receive the emails.

In addition a number of the emails are sent to certain administrators of the Host Server. In the Admin Console you can mark an Admin User as a receiver of “Email Notifications”. By default, this is enabled for all administrators.

### 9.1 Depot Overflow

A depot overflows when the storage usage exceeds the specified storage limit.

At this point users are notified and are expected to take action to either reduce the storage used by a depot by deleting files and snapshots or by increasing the depot limit.

In this state, synchronisation is stopped in the sense that uploaded changes to files are not forwarded to other clients. This is because the Host Server prevents files uploaded during the overflow state from being downloaded. Only once the depot is below the 100% limit are those files released for download. Files uploaded before the overflow may always be downloaded.

In addition, depots have an “overflow limit” and a “maximum overflow upload rate” which apply when the depot is full. This value depends on the actual depot storage limit as follows:

Depot limit	Overflow limit	Max Upload Rate
< 3 GB	10 GB	1 GB per day
< 120 GB	50 GB	2 GB per day
>= 120 GB	100 GB	4 GB per day

When a depot reaches the depot limit **plus** the overflow limit, the depot is “frozen”. When a depot is frozen upload and download of files is no longer permitted. In general this stops all synchronisation because operations that are queued after a file upload are blocked and will not be synchronised until the file is uploaded.

This means that in the frozen state it may not be possible to delete files or snapshots, or even invite or join a space. So the only sure way to “unfreeze” a depot is to increase the depot storage limit.

Warning email notifications are sent when the depot reaches the 80% and 100% full.

As mentioned above, when the depot reaches the 100% storage limit, the Host Server still allows file uploads, but it limits the upload rate, according to the “Max Upload Rate” specified in the table above. This ensures that the user has a number of days to respond to the overflow conditions of the depot before it is frozen. For example.

if the maximum upload rate is 4 GB per day, and the overflow limit is 100 GB, then it will take at least 25 days before the depot is frozen.

During this time, the Host Server sends a number of emails to the owner of the depot, the managers of the account that owns the depot, and Host Server administrators.

Emails are sent when the storage exceeds 20% and 50% of the overflow limit. When it reaches 100% of the overflow limit an email is sent to inform users and managers that the depot has been frozen.

## 9.2 Related Settings

The `EnableSpaceReductionProcess` must be set to `True` in order to enable automatic storage space reduction (see `enablespacereductionprocess` for details).

If the `AllowAutoDeleteSpaces` setting is set to `False` then the space reduction process will not actually delete any spaces (see `allowautodeletespaces`).

The purpose of this setting is to quickly suspend the deletion of spaces (without disabling the entire process) in case there is reason to believe spaces will be deleted that should not be deleted. The administrator is then able to review spaces that have been scheduled for deletion.

## 9.3 Email Notifications

The Host Server sends the following email notifications:

**Depot 80% Full Warning:** The owner and managers of the depot are sent a warning email that the depot has exceeded the 80% threshold.

**Depot 100% Full:** The owner and managers of the depot are sent a warning email that the depot has exceeded the storage limit.

- At this point, if the depot size has not been recalculated with the last 60 days, then the space usage of the depot will be recalculated.
- The data upload rate to all spaces of the depot is limited by the Host Server depending on the storage limit of the depot (see table above).

**Depot 20% Overflow Warning:** The owner, managers and Host Server administrators are sent a warning email that the depot will be frozen if it exceeds the specified overflow threshold.

**Depot 50% Overflow Warning:** The owner, managers and Host Server administrators are sent a second warning email that the depot will be frozen if it exceeds the specified overflow threshold.

**Depot 100% Overflow:** The owner, managers and Host Server administrators are informed that the depot has been frozen and that all synchronisation has been stopped.

**60 Day Deletion Warning:** The owner and managers are sent an email warning the users that the spaces in the depot will be automatically deleted if the storage usage is not reduced below 100%.

This email is sent when the following conditions hold:

- The depot usage exceeds the 5% overflow limit.  
For example if the depot limit is 200 GB, then the overflow limit is 100 GB therefore 5% of the overflow limit is 5 GB. So this warning will only be sent when the depot usage exceeds 205 GB.
- The depot has been in the overflow state for a number of days equal to the default snapshot age (see `DefaultSnapshotMaximumAge` setting). However this pause is never shorter than 10 days, or longer than 60 days.

This is intended to allow for possible reduction in storage usage due to the deletion of snapshots created before the depot overflowed.

**30 Day Deletion Warning:** Thirty days after sending the 60 day warning, the server sends a further deletion warning to the depot owner and account managers. Host Server administrators are also notified of this condition.

**10 Day Deletion Warning:** The depot owner, account managers and the designated Host Server administrators are sent a 20 day deletion warning email.

This email is sent 20 days after the 30 day warning email.

**3 Day Deletion Warning:** Seven days after the 10 day warning the server sends a 3 day deletion warning. This warning is only sent the depot owner and account managers.

**1 Day Deletion Warning:** Two days after the 3 day warning the server sends a 1 day deletion warning. This warning is only sent the depot owner and account managers.

**Depot Size Reduced:** One day after the 1 day warning the server deletes spaces in order to reduce the storage usage of the depot below the specified storage limit.

Spaces are deleted beginning with the those that have the oldest last access date.

After deletion is complete an email is sent to the depot owner, account managers and the Host Server administrators with a list of the IDs of the spaces that have been deleted.

Space are only deleted if the following hold:

- The settings `EnableSpaceReductionProcess` and `AllowAutoDeleteSpaces` are set to `True`.
- The depot has been idle for at least 60 days. This means that the no space has been accessed in the depot for over 60 days.

If these conditions are not met then the Host Server sends a **Spaces Not Deleted** email.

**Spaces Not Deleted:** One day after the 1 day warning is sent, if the condition described above in the **Depot Size Reduced** email, then the server sends this email.

This email explains to the users that spaces will be deleted as soon as the specified conditions hold.

**Deletion Cancelled:** This email is sent to the depot owner and the account managers any time after the 60 day warning has been sent, if the depot storage usage drops below the 100% storage limit threshold.



## SETTING UP AN AMAZON S3/AZURE BLOB STORAGE/CEPH OBJECT STORAGE-COMPATIBLE OBJECT STORE

Installation and configuration of the TeamDrive Daemon `s3d` is only required if TSHS (see *TeamDrive Scalable Hosting Storage* (page 57) for details) is not enabled and you have an Amazon S3/Azure BLOB Storage/Ceph Object Storage compatible object store you wish to use as a secondary storage tier.

Currently, Amazon S3, OpenStack Swift, Ceph Object Gateway (version 0.8 or higher, using the S3-compatible API) or Azure BLOB Storage are supported.

`s3d` is a process that runs in the background and provides secondary storage by transferring files to the object store. It does this by monitoring the hosted data directory structure and transferring files to the object store when a file reaches an age as specified in the service's configuration. The configuration settings also allows you to specify what files are eligible to be transferred via the use of pattern matching.

---

**Note:** Because all object store requests will be signed using the current timestamp, it's essential that the system time is accurate when running `s3d`. Make sure that the NTP service is installed and running. See the chapters about NTP configuration in the installation guides for details.

---

### 10.1 Configuring `s3d`

The configuration of `s3d` is performed by changing the relevant configuration settings using the Host Server Administration Console.

Log into your Host Servers Administration Console at <https://hostserver.yourdomain.com/admin/> and click on **Settings** → **Object Store**.

The following information is needed by `s3d` to connect to the object store.

**S3Brand** This setting specifies the type of S3 storage. Valid options are: **Amazon**, **OpenStack** or **Azure**.

**S3Server** Your object store's domain name, e.g. `s3.amazonaws.com` or `youraccount.blob.core.cloudapi.de`. By default the HTTP protocol will be used. To change this, specify a full URL, including port if necessary, for example: `https://youraccount.blob.core.cloudapi.de`.

**S3Region** The region used by the Amazon Signature Version 4 signing process. This value must be set correctly if you have enabled Version 4 signing by adding the `UseSignatureV4=True` option to the `S3Options` setting. If not specified the value "eu-west-1" will be used. Otherwise the value must be set according to the following mapping: [Amazon Regions and Endpoints](#)

**S3DataBucketName** The name of the Bucket in the object store that will contain the Space data. The bucket must already exist.

**Warning:** If you are setting up multiple TeamDrive Hosting servers it is important that they do not use the same Bucket. Doing so can result in data loss.

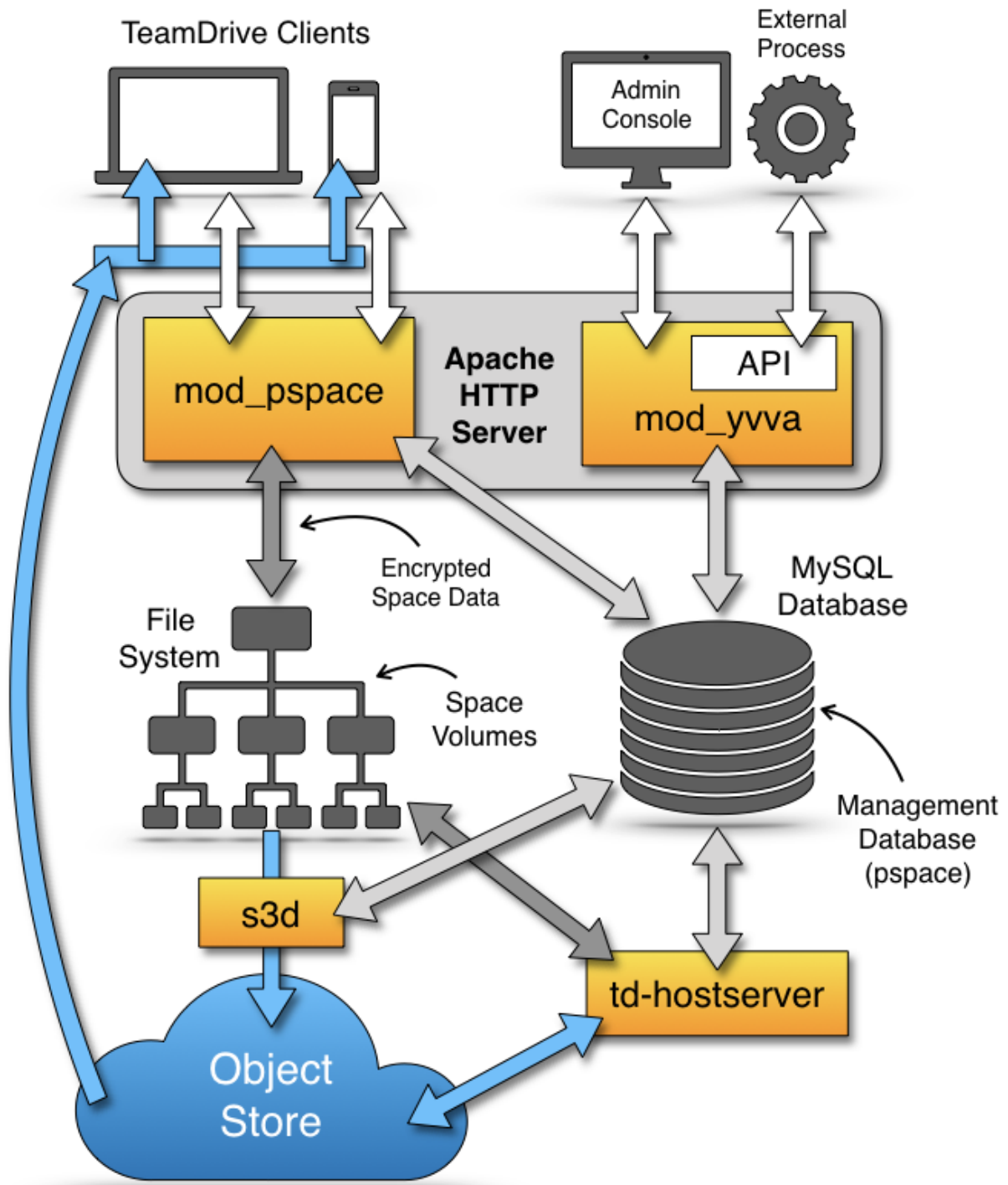

Fig. 10.1: TeamDrive Hosting Service using an object store



**S3AccessKey** Your object store access (public) key, used to access the specified bucket.

**S3SecretKey** Your object store secret (private) key used to access the specified bucket.

**S3SyncActive** Set this to `True` to enable the synchronization of data stored by the Host Server (Space data) to the specified bucket on an compatible object store. Note that the synchronization won't start until the `s3d` service has been started (see below).

**S3Options** These options control the way the object store is accessed, for example the number of parallel threads during upload, whether to use multipart upload, etc. The options may also contain `S3Brand` specific settings.

Options must be separated using a semi-colon (";").

**S3EnableRedirect** When S3 redirect is enabled, the Host Server will redirect the Client to a download directly from the object store, when appropriate. This helps to offload traffic from the Host Server to the object store. If set to `False`, the Host Server fetches the requested object from the object store and serves it to the Client directly.

## 10.2 Starting and Stopping the `s3d` service

You can use the `/etc/init.d/s3d` init script to start and stop `s3d`. The configuration setting `S3SyncActive` needs to be set to `True`, otherwise `s3d` will abort with a corresponding error message.

**Warning:** Enabling the `s3d` Daemon means that any new data in existing Spaces and new Spaces will be transferred to the object store. Currently, there is no automatic way to return back to a pure file-based Host Server setup — data that was moved to the object store stays in object store. Disabling the secondary storage tier would result in Clients no longer being able to access their Space data.

After starting `s3d` with the command `service s3d start`, check the log file `/var/log/s3d.log` for startup messages. You can use `service s3d status` to check if `s3d` is up and running.

`s3d` should be added to the processes to be started at boot time. To do this execute the following commands as root:

```
[root@hostserver ~]# chkconfig s3d on
```

## 10.3 Optional configuration parameters

The following optional configuration options can be modified in the `S3Options` configuration setting:

**MinBlockSize** The minimum block size that can be used for multi-part upload. The valid range of this parameter will be determined by the implementation of the object store being used.

**MaxUploadParts** The maximum number of parts a file can be divided into for upload. The valid range of this parameter will be determined by the implementation of the object store being used.

**MaxFileUploadSize** Files larger than this will not be transferred to S3. The default, 0, means all files are uploaded.

**MaxUploadThreads** The thread pool size to use for multi-part uploads. The default, 0, means single threaded.

**BucketAsSubdomain** Amazon S3 uses the bucket name as part of the domain name (`BucketAsSubdomain=1`), while other object stores (e.g. Azure or OpenStack) include the bucket name as part of the path name after the domain (`BucketAsSubdomain=0`). This option usually does not have to be set explicitly, as the `S3Brand` setting determines this value automatically.

**MaxBandwidth** The S3 Daemon could be limited to avoid bandwidth conflicts with the clients. The value you have to enter is the used bandwidth in MB/s. The default, 0, means no limitation.

## 10.4 OpenStack configuration parameters

If the `S3Brand` is set to `OpenStack` then 2 additional parameters are required in `S3Options`, to enable the generation of temporary URLs. Temporary URLs give clients temporary direct access to objects in the object store, helping to reduce network traffic on the Host Server. This requires the setting `S3EnableRedirect` to be set to `True`.

**OpenStackAuthPath** This is the path component of the OpenStack Authorization URL. For example if the OpenStack Authorization URL is `https://swift-cluster.example.com/v1/AUTH_a422b2-91f3-2f46-74b7-d7c9e8958f5d30` then the `OpenStackAuthPath` would be `/v1/AUTH_a422b2-91f3-2f46-74b7-d7c9e8958f5d30`.

**OpenStackAuthKey** Your OpenStack temp URL key used to generate temporary URLs.

Your OpenStack administrator should be able to provide you with the OpenStack Authorization URL and the corresponding temp URL key.

**Warning:** The generation of new temp URL keys will invalidate older keys. It is important that once the temp URL key has been set for your TeamDrive Hosting server that no new keys are being generated.

## 10.5 Enabling Object Store Traffic Usage Processing

When S3 storage has been enabled, TeamDrive Clients access the data in the object store directly. The traffic required by these operations is recorded by reading the object store access log files.

This means that setting `S3SyncActive` to `True` changes the way Traffic usage is calculated. When `S3SyncActive` to `False`, the Hosting Service is able to record all traffic usage in the `pspace` database. When `S3SyncActive` to `True` the object store access logs must be downloaded and parsed to get the required information.

---

**Note:** At present, only Amazon S3 and Azure BLOB Storage supports the concept of providing access log files via a dedicated log bucket (S3) or log folder (Azure). If your object store doesn't support providing access logs, leave the following four settings empty. The host server will calculate the file size of each returned redirect URL to the external object store as traffic for this space. This might be not exact, because a client might send a download request for the same file again in case that the download was not complete. The download will then start at the offset where the former download stopped. A new redirect will not result in a full file download in this case. In case your object store offers access logs, the traffic usage processing expects the Amazon S3 / Azure BLOB Storage access log format. See [S3 Server Access Logging](#) in the Amazon S3 documentation for details or [Azure Storage Logging](#) on how to enable server access logging.

---

In addition, the following configuration settings have to be defined:

**S3LogBucketName:** Name of the bucket (S3) / \$logs-folder (Azure) that contains the access logs. Note that if this setting is empty, the object store traffic will not be calculated. You must configure your object store to save the access logs to this bucket / \$logs-folder. Please refer to your object store documentation to determine how this is done.

---

**Note:** The bucket used for the log files **must be a dedicated bucket**. This is because the script that processes the files download everything assuming the bucket only contains log files.

---

**S3ToProcessPath:** Local path in the filesystem to download above access logs for further processing. By default, this path is set to `/var/opt/teamdrive/td-hostserver/s3-logs-incoming/`

**S3ArchiveLogs:** If set to `True`, the processed access logs will be moved to the folder defined in the next setting `S3ProcessedPath`.

---

**S3ProcessedPath:** If logs need to be kept for own additional analysing, then the access log files will be moved to this directory once traffic usage Processing is complete.

By default, the task `Process S3 Logs` that calculates the traffic runs every 10 minutes.



## TEAMDRIVE SCALABLE HOSTING STORAGE

If you require a scalable hosting system that grows with the number of users, then you have 2 alternatives:

- Use a scalable file system that allows multiple access points, or,
- Use TSHS, which stores the data in a cluster of MySQL databases.

The TeamDrive Scalable Hosting Storage, TSHS, is a scalable storage system for the TeamDrive Hosting Service based on the MySQL database. It is an alternative to the standard file system based TeamDrive Hosting Service.

If you are not sure of your requirements, you can begin with file system based storage. If your requirements outgrow a file system-based configuration, you can upgrade to TSHS at any time. How to do this is described in the section *Upgrading to TSHS* (page 62).

By default, TeamDrive Hosting Service stores files in the local file system. When TSHS is enabled, the Hosting Service stores files in a cluster of MySQL Servers (not to be confused with MySQL Cluster NDB). Each server in the cluster stores a partition (known as a “shard”) of the data. TSHS refers to such a database server as a “Storage Node”.

One of the databases in the cluster contains the administration data for the cluster, and this is known as the “Admin Node”. The Admin Node contains a list of Storage Nodes in the cluster, and is the starting point for connecting to the cluster.

Scale-out can be achieved by placing each database (Storage Node) in the cluster on a different machine. When a Storage Node exceeds its capacity (either in the terms of storage or computing power), the shard that it contains can be split, which creates a new Storage Node.

Whenever a Storage Node (or the Admin Node) is created, the system administrator must first create an empty MySQL database that will be used by the Node. In this way the administrator can control where the data for the Node will be stored, and how scale-out is achieved.

### 11.1 TSHS and Object Storage

In general, the TeamDrive Hosting Service is capable of using an object store as secondary storage. This is also the case when using TSHS. An object store is used as secondary storage to provide unlimited capacity if this is not provided by the primary storage (the file system or TSHS database cluster).

When using the file system for storage, `s3d` (the TeamDrive `s3d` Daemon) is responsible for transferring files to the object store. This job is done by the `tshs` command line tool when TSHS is enabled (see below).

The object store also serves as a backup for the data in the primary storage. If the primary storage is lost for some reason the data can be restored from the object store. The actuality of the restored data will depend on the frequency with which data is moved to the object store.

The frequency of this operation can be set by the administrator in the configuration of the `s3d` or the `tshs` tool. Nevertheless, it is likely that data is lost in the most active spaces upon restore. This eventuality is handled by the TeamDrive Client if the correct restore procedure is followed, as described before.

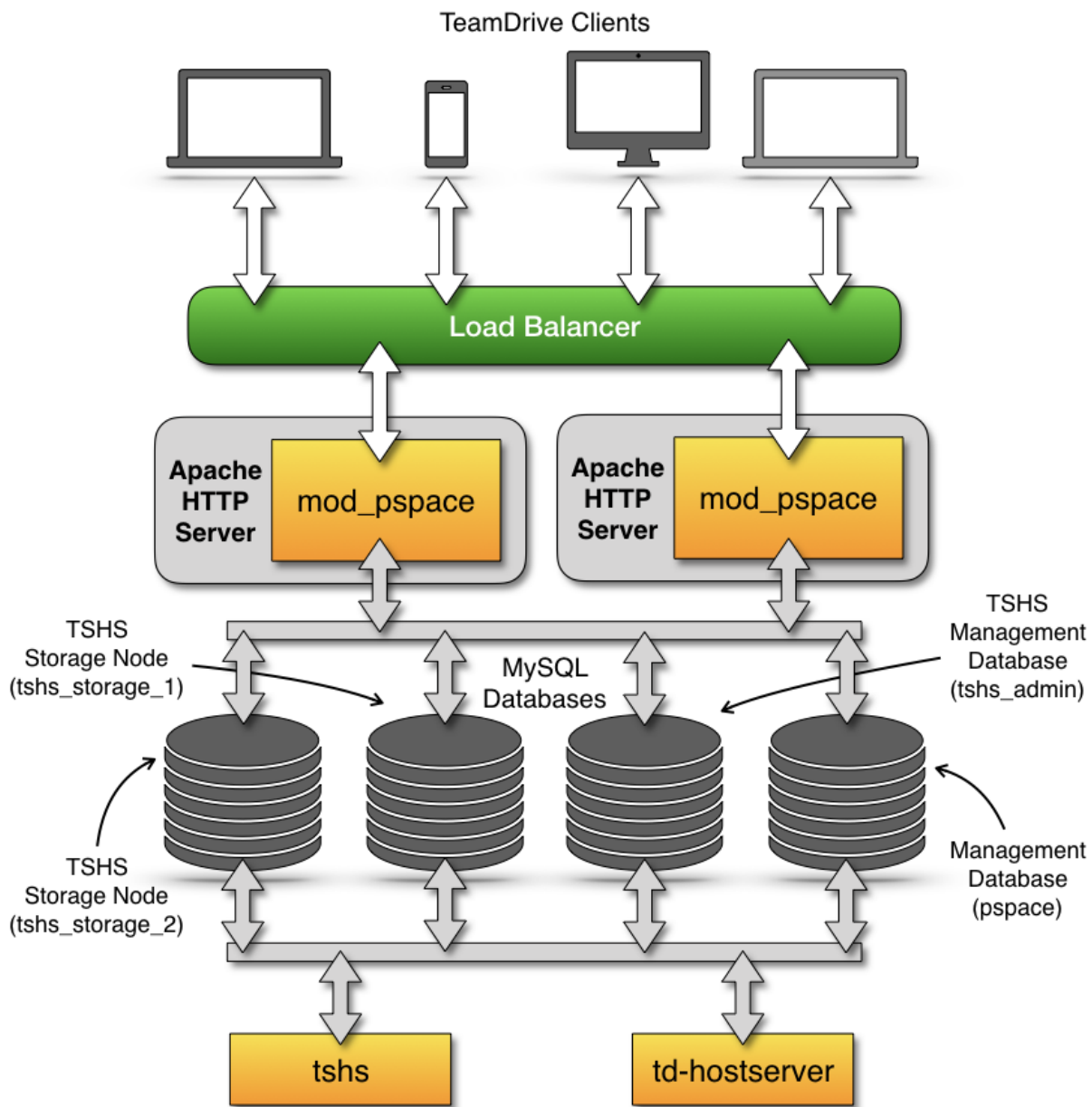

Fig. 11.1: TeamDrive Scalable Hosting Storage (TSHS)

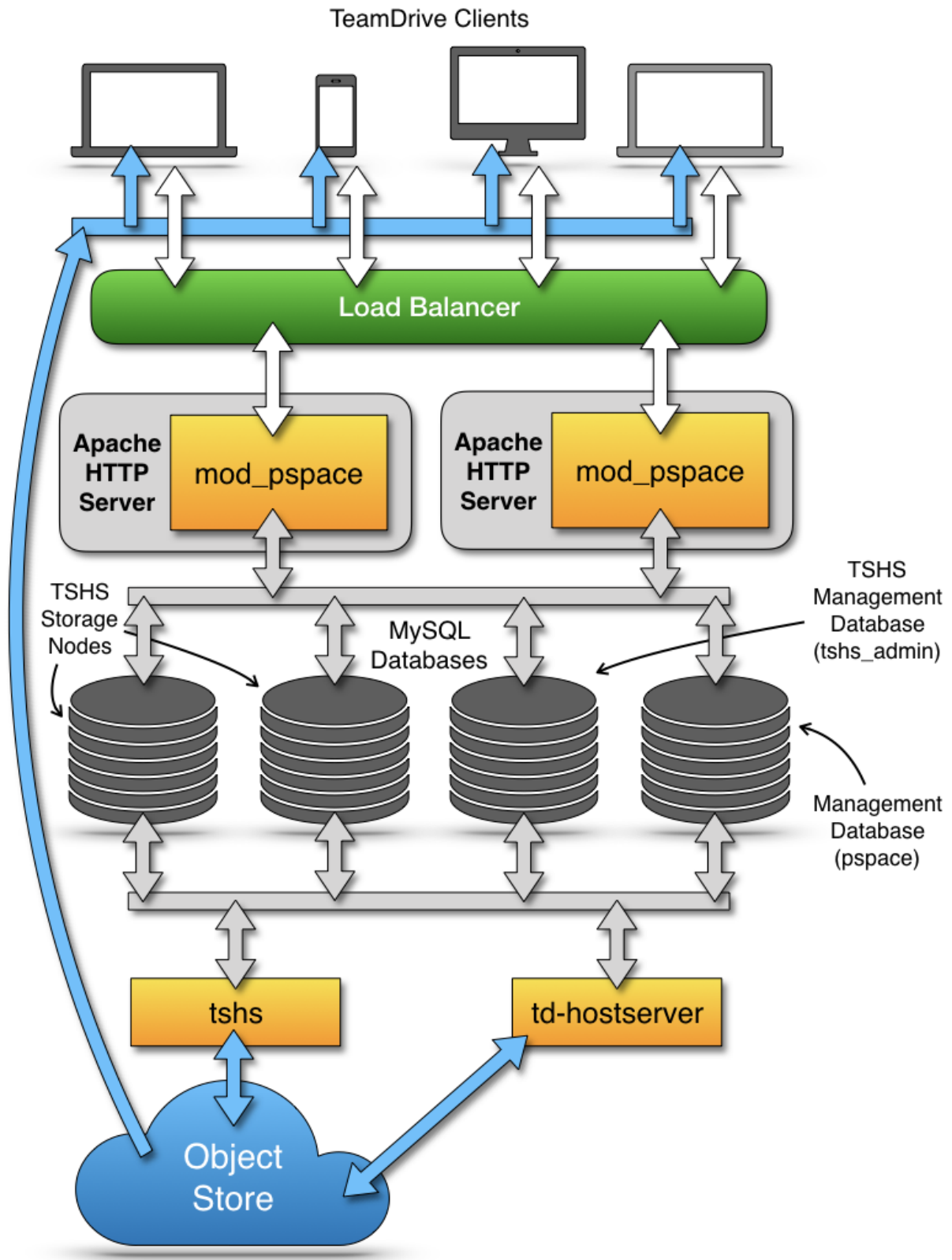

Fig. 11.2: TeamDrive Scalable Hosting Storage (TSHS) with an object store

## 11.2 The `tshs` Command Line Tool

The TSHS cluster is managed using the `tshs` command line tool. The command line tool is all you need to create, maintain and expand the TSHS cluster. Alternatively, you can use the Host Server Administration Console, which calls `tshs` in the background to perform the requested task.

The `tshs` command line tool can be used in 3 different modes:

1. **One off commands:** Run `tshs` with command line arguments to perform various once-off tasks, such as create a new Storage Node, split a Storage Node or add a reference to an S3 compatible object store.
2. **Interactive “shell” mode:** To introspect and perform a number of commands on a cluster the easiest is to start `tshs` in interactive mode, also known as shell mode. In this mode you can run all command line operations, in addition to a few shell only commands.
3. **Background “daemon” mode:** A number of tasks need to be started regularly. These are basically TSHS commands that are run repeatedly by `tshs` running in daemon mode. For example, if a Storage Node is split, then data must be copied from one node to the other. The `copy-shards` maintenance command does this.

All maintenance tasks can be run in parallel, and from any machine. This way, it is possible to scale-out the maintenance operations. Additional `tshs` commands can be run to increase the throughput of any task that needs to be performed.

For example, when a node split occurs, a lot of data may need to be transferred from the old to the new Storage Node. Each `copy-shards` command only transfers one file at a time. So, starting (for example) 10 `tshs` instances running the `copy-shard` command will transfer 10 files simultaneously.

Enter `tshs help` to get a full list of commands provided by the `tshs` command line tool.

## 11.3 Creating a TSHS-based TeamDrive Hosting Service

The first step is to create a `tshs_admin` database, setup the `[tshs]` MySQL group and enable TSHS in the Hosting Administration Console as described in the section *Initializing a TSHS Cluster* (page 61) below.

Following this, to the menu item **Host -> TSHS** and create a Storage Node as described in the section *Creating a Storage Node* (page 61).

After you have successfully created a storage node, you need to restart all Apache instances. TSHS cluster usage should then begin immediately. Check the Apache error log (e.g. `/var/log/httpd/error_log`) to ensure that the module has loaded correctly, and that no errors occurred. You should see something like this:

```
[notice] mod_pspace 1.5.04 Loaded; Build Jun 18 2014 18:15:23;
Crash-Reporting-Disabled
[notice] Admin API booted: TSHSEnabled; Importing Volumes; S3 n/a; Path:
/spacedata
```

You can confirm that the TeamDrive Apache module has connected to the TSHS cluster by running the `tshs list-access-points` command:

```
$ tshs list-access-points
ID      Ack Access time      Description
-----
205     1    2014-06-20 15:57:41  pspace module;host=www.teamdrive.com;pid=75744
206     1    2014-06-20 15:57:41  pspace module;host=www.teamdrive.com;pid=75742
207     1    2014-06-20 15:57:41  pspace module;host=www.teamdrive.com;pid=75741
208     1    2014-06-20 15:57:41  pspace module;host=www.teamdrive.com;pid=75743
209     1    2014-06-20 15:57:41  pspace module;host=www.teamdrive.com;pid=75745
210     1    2013-03-26 21:24:42  pspace module;host=www.teamdrive.com;pid=75746
211     1    2014-06-20 15:57:41  tshs shell;host=www.teamdrive.com;pid=75765
```



This command lists all processes connected to the TSHS cluster. In the example above, the “pspace module” is listed a number of times, once for each process started by Apache.

## 11.4 Initializing a TSHS Cluster

A TSHS Cluster is initialized by creating an “Admin Node”, which is simply a MySQL database within the cluster with the name (by default) `tshs_admin`.

As mentioned above, a TSHS Cluster consists of a group of MySQL databases. The topology (i.e. the configuration of databases, MySQL servers and hardware) of the database cluster is determined by the administrator. However, it is obvious that maximum scalability is achieved by placing each database on its own hardware.

The databases used by TSHS must always be created by the administrator. The administrator determines the name of the user that will be used by TSHS to access the database, and grants the TSHS user the required rights. In order to create a node (Admin or Storage), TSHS requires the right to create its own tables in the database. After that point it only needs complete access to the tables it has created.

Observe the following steps to initialize a TSHS cluster:

1. **Create the `tshs_admin` database:** Start by creating a database called `tshs_admin`. Add a user to the database (for the purpose of this documentation we will call the user `teamdrive`) and grant the user the right to create tables.
2. **Configure the MySQL connection:** Create an options group called `[tshs]` in your MySQL options file (`/etc/td-hostserver.my.cnf` file). The `[tshs]` group contains the MySQL connection parameters used to connect to the `tshs_admin` database:

```
[tshs]
database=tshs_admin
user=<tshs-username>
password=<tshs-password>
host=localhost
port=3306
socket=/var/lib/mysql/mysql.sock
```

How to setup a MySQL connection is explained in the MySQL documentation: <http://dev.mysql.com/doc/refman/5.6/en/option-files.html> . Use the `--mysql-cfg-file` option to specify the location of the MySQL options file on the `tshs` command line, if you are not using the default location (`/etc/td-hostserver.my.cnf`).

3. **Create the Admin tables:** This is done by using the Hosting Administration Console (menu item **Settings** → **TSHS Settings**) to set the configuration setting `TSHSEnabled` to `True`.

When TSHS is enabled, the Console will run the `tshs create-admin-node` command which creates and initializes the tables used by TSHS in the `tshs_admin` database. The command will succeed if TSHS is able to access the `tshs_admin` database you have already created. If the tables already exist, the command has no effect.

The `[tshs]` group described above is the entry point for accessing the entire TSHS cluster. Connection information to other nodes is stored in the `tshs_admin` database itself.

After TSHS has been enabled, the Administration Console will display an additional entry **TSHS** located below the **Host** section of the left navigation bar. Use this page to manage TSHS.

## 11.5 Creating a Storage Node

Before data can be stored in a TSHS cluster you need to create one or more Storage Nodes.

To create a Storage Node, you must first create an empty MySQL database. The location of the database depends in the topology of your cluster but, as mentioned before, the database must run on its own machine for maximum scalability.

The database may have any name you choose and must contain a user that has the right to create tables. We will call this user `teamdrive` for the purpose of this documentation.

Under the menu item **Host -> TSHS**, choose the `create-storage-node` command, and enter the connection options for accessing the database you have just created in the **Parameters** text field. The `<connection-options>` is a list of MySQL connection options separated by a semicolon (`;` character).

For example:

```
user=teamdrive;password=<password>;host=127.0.0.1;database=tshs_storage_1
```

You can use any options that you would otherwise use in a MySQL options file. A complete list of options is provided in the table on this page:

<http://dev.mysql.com/doc/refman/5.6/en/mysql-options.html>

Now press the **Execute** button to run this command using `tshs`.

This will execute the command `tshs create-storage-node <connection-options>` to create TSHS Storage Node.

This command may only be executed when all Storage Nodes are empty in the cluster. As soon as the cluster contains data, you need to use the `split-shard` command to create new Storage Nodes.

Under **Host -> TSHS**, the Hosting Administration Console displays a list of Storage nodes you have created. The list all the Storage Nodes displayed by the Console is obtained by using the `tshs list-storage-nodes` command:

```
$ tshs list-storage-nodes
ID  Phase           Boundary (size)           Connection options (totals)
-----
1   ACTIVE_SHARD   0 (2147483648)           user= td;port=3306;database=tshs_storage_1
(InDB=4558 OnS3=2677 R/O=3013 Bytes=4651260)
2   MIRROR_SHARD  2147483648 (2147483648) user=td;port=3306;database=tshs_storage_2
(InDB=5812 OnS3=3908 R/O=3102 Bytes=4523606)
```

Data can be stored in the cluster as soon as you have one Storage Node. However, it is possible to start with several Storage Nodes if you are expecting the cluster to grow large. This will save splitting shards later, which is an expensive operation. Create additional Storage Nodes by calling `create-storage-node` several, times. Each time you must provide a new empty MySQL database. As long as the cluster is empty you can create and delete Storage Nodes until you have the desired start configuration.

Ideally, you should not need to change the topology of your TSHS cluster (other than adding new Storage Nodes) once it is in use. Changing the topology effectively requires changing the connection options stored for a particular Storage Node, as a result of moving one of the storage databases to a different machine or MySQL server. Although this is possible, it currently requires the entire cluster to be shutdown before changing the connection options (shutting down the cluster is done by stopping all the Hosting Service Apache instances).

If the database needs to be copied, then the cluster must remain shut down during this time. You can shorten the downtime, by using MySQL replication to create a copy of a Storage Node database before changing the topology of the cluster.

## 11.6 Upgrading to TSHS

An existing file system based TeamDrive Hosting Service can be easily upgraded to use TSHS. This process is automatic, and runs while the system is online.

**Note:** If your existing Hosting Service uses an S3 object store you must **stop and disable the TeamDrive S3 Daemon background task** (`s3d`) before you enable TSHS:

```
[root@hostserver ~] service s3d stop
[root@hostserver ~] chkconfig s3d off
```

However, the setting `S3SyncActive` must remain set to `True`.

When you enable TSHS, the Hosting Administration Console will check to see if file system storage is active. If so, it will automatically set the configuration setting `TSHSImportVolumes` to `True`.

When `TSHSImportVolumes` is enabled, the data in the File System volumes will be transferred in the background to the TSHS cluster. This transfer occurs automatically, while the system is online.

The main work of importing the data into TSHS is done by the `tshs perform-import` command. TSHS is configured to perform this command by default.

The command checks to if an import job is active, and if so, executes the import. You retrieve the status of an import jobs by listing all “jobs” in the system using `tshs list-jobs`:

```
$ tshs list-jobs
ID      Job      Parameters
-----
236887  IMPORT  path=/spacedata;s3-host-id=6
```

The example shows that an import job is in progress. If an S3 object store is in use, then the job contains a reference to an S3 host (see `tshs list-s3-hosts` above).

Although it can be run while the Hosting Storage is online, the `perform-import` command places quite a load on the system. If necessary the command can be run at non-peak times, for example, for a few hours every night until the import is complete. Using the `--time-limit` option you can limit the time a maintenance task will run.

As soon as the `perform-import` task has completed successfully, it is recommended to disable `TSHSImportVolumes` (set the setting to `False`). The name of the job is changed from `IMPORT` to `IMPORTED` when all data has been transferred from the File System volumes to TSHS.

Disabling `TSHSImportVolumes` is an important optimisation because TSHS no longer to search the File System (or S3 Storage if enabled) in order to find files requested by the TeamDrive Client. When import is complete, all the required information on the location of files is stored in the TSHS cluster.

## 11.7 Scaling Out the Cluster

When a Storage Node reaches its capacity, either in terms of storage or computing power, then the data shard on the node needs to be split.

The `tshs split-storage-node <storage-id> <connection-options>` operation splits the shard on a given node, and creates a new Storage Node at the same time. For example:

```
tshs split-storage-node 2
user=teamdrive;password=<password>;database=tshs_storage_3
```

The `<storage-id>` parameter is a reference an existing Storage Node which you want to split. Approximately half the files that reside on the this Storage Node will be moved to the new Storage Node (using copy and delete operations).

As described above, before you can create a new Storage Node, you must create an empty MySQL database. The `<connection-options>` operation parameters specify the MySQL options required to connect to the new empty MySQL database.

After you have split a Storage Node shard you need to run the `tshs copy-shards` maintenance command. This command copies all files as required from the old Storage Node to the new Storage Node. This operation can be sped up by starting a number of `tshs copy-shards` commands in parallel. Of course, the more copy operations running, the greater the load on the MySQL databases involved. As a result it is recommended that you monitor the database load during this time and start or stop copy operations as appropriate. The new Storage Node remains in `MIRROR_SHARD` state until the copy operation is complete.

Note that by default the `tshs` command is setup to run in daemon mode, and perform all outstanding tasks. This includes the `copy-shards` command.

A Storage Node shard can be split while the cluster is online. Neither the `split-storage-node` or `copy-shards` command interrupt normal operation of the cluster, other than causing increased load due to the copy operation.

The copy operation must be complete (i.e. the Storage Node must be in the `ACTIVE_SHARD` phase) before it can be split again.

## 11.8 Connecting TSHS to an S3 Compatible Object Store

When TSHS is connected to an S3 compatible Object Store, it periodically transfers files from the Storage Node database(s) to the Object Store. This is done by the `tshs move-to-s3` maintenance command.

In order to enable the transfer of data to the object store, TSHS needs to be configured for accessing it. This can be done by taking the S3-specific setting from the Host Server settings and adding the necessary access details to the `tshs_admin` database using the command `tshs add-s3-host`.

Ensure that the settings `S3Brand`, `S3Server`, `S3Region` (if using Amazon Signature Version 4), `S3DataBucketName`, `S3AccessKey` and `S3SecretKey` contain the correct information to access the S3 bucket that will be used to store the Hosting Service data. See chapter *Configuring s3d* (page 51) for details.

`add-s3-host` will ping the S3 service before actually adding the host details.

The Hosting Administration Console will then take these settings to create the TSHS-specific S3 host entry when you enable S3 by setting the configuration setting `S3SyncActive` to `True`.

You can verify this by running `tshs list-s3-hosts` on the command line or via the Hosting Administration Console.

If any of these setting are incorrect, enabling S3 will fail with an appropriate error message.

---

**Note:** You need to restart the Apache HTTP Server using `service httpd restart` after enabling `S3SyncActive`. Check the log file `/var/log/httpd/error_log` for the following notice:

```
[notice] Admin API booted: TSHS Enabled; S3 Enabled (s3d n/a)
```

---

The Hosting Administration Console sets up the S3 host in the cluster by executing the following command:

```
add-s3-host <brand> <server> <bucket> <access-key> <secret-key> [<options>]
```

For example:

```
tshs add-s3-host AMAZON s3.amazonaws.com my-bucket 022QF06E7MXBSAMPLE
kWcrlUX5JEDGM/SAMPLE/aVmYvHNif5zB+d9+ct
MaxAge=1;MinSize=1;MinBlockSize=5M;MaxUploadParts=1000;MaxUploadThreads=10
```

Currently, `<brand>` must be set to `AMAZON` or `OPENSTACK`. `<server>` is the host name of the server (for amazon this is `s3.amazonaws.com`). `<bucket>` is the name of the S3 bucket. `<access-key>` and `<secret-key>` are the keys required to access the bucket.

The Hosting Administration Console takes these values from the associated configuration settings.

The `<options>` string has the form: `<name>=<value>;<name>=<value>;...`

Options are:

**MinSize** The minimum size of a file that will be uploaded to S3. Use K=Kilobytes, M=Megabytes, etc.

**UrlTimeout** The time in seconds that a redirect for reading is valid. The default is 10.

**MinBlockSize** The minimum block size that can be used for multi-part upload. Default is 5MB. The valid range of this parameter will be determined by the implementation of the object store being used.

**MaxUploadParts** The maximum number of parts a file can be divided into for upload. Default is 1000. The valid range of this parameter will be determined by the implementation of the object store being used.

**MaxFileUploadSize** Files larger than this will not be transferred to S3. The default, 0, means all files are uploaded.

**MaxUploadThreads** The thread pool size to use for multi-part uploads. The default, 0, means single threaded.

The options value used by Hosting Administration Console is stored in the `S3Options` configuration settings.

When an S3 host is added it, becomes the current S3 host. All files uploaded to S3 storage automatically go to the current S3 host. You can set the current S3 host using the command `tshs set-current-s3-host <host-id>`.

You can list all S3 hosts with the `list-s3-hosts` command:

```
$ tshs list-s3-hosts
ID  Cur Server          Bucket          Public Key          Private Key
Options
-----
-----
6   yes s3.amazonaws.com mybucket  022QF06E7MXBSAMPLE
kWcrlUX5JEDGM/SAMPLE/aVmYvHNif5zB+d9+ct
MinSize=1;UrlTimeout=10;MinBlockSize=5K;MaxUploadParts=1000;MaxUploadThreads=2
```

To check the file transfer progress, you can use the command `tshs transfer-to-s3-info`, which will display how many files and their total size are ready to be transferred.

These commands can be executed from the command line, or by using the **Host -> TSHS** Hosting Administration Console page.

---

**Note:** If you wish to change S3 parameters, then first set `S3SyncActive` to `False`, then change the parameters and set `S3SyncActive` back to `True`. Note that if the S3 parameters are changed, data is already stored in S3 will continue to use the old parameters! If you wish to change the S3 parameters of existing S3 data, then you must use the `tshs update-s3-host` command.

---

TSHS supports the following additional S3 related commands `disable-s3-host`, `enable-s3-host` and `delete-s3-host` that allow for disabling/removing the synchronization of objects to an S3-compatible object store. Calling `disable-s3-host` marks a host entry as “disabled”. Calling `delete-s3-host` deletes a host entry unless the entry is referenced by a file. In this case the entry will be marked as deleted. If an entry is marked as disabled or deleted, no further data will be uploaded to the object store. However, accessing existing objects from the object store will continue to work. Calling `enable-s3-host` will re-enable the synchronization of objects to the object store, including the upload of all objects that have been uploaded to TSHS while the object store was marked as disabled. If a disabled or deleted host is marked as current, then TSHS will generate an error on each write attempt.

## 11.9 Running Maintenance Tasks

The following maintenance tasks must be run periodically:

**copy-shards** If a Storage Node has been split, this task copies files from the old storage node to the new node, which contains the new shard.

**remove-deleted** This task removes files from the cluster that have been marked for deletion. This includes removing files from S3 storage.

In general, the TeamDrive Scalable Hosting Storage does not delete files in the cluster immediately, but rather marks them for deletion. This can also take the form of a DELETE job, if an entire space is deleted.

DELETE jobs that have been scheduled are displayed using `tshs list-jobs`. If a file is marked for deletion then this can be seen when you use the `tshs list-files` command.

**perform-import** This task imports existing file system based Hosting data into the TSHS cluster.

**move-to-s3** This task moves files to S3 storage that have been scheduled for transfer. The TeamDrive Hosting Apache module schedules files to be moved to S3 storage, as soon as the writing of the file is concluded. Files marked to be transferred, and copied to S3 by the `move-to-s3` and then removed from the cluster.

**copy-to-s3** This task performs a backup of files that need to remain in the TSHS cluster. Currently this is all files called `last.log`. The `last.log` files are constantly updated and may therefore never be moved to S3 permanently. Whenever a `last.log` file is modified it is marked to be copied to S3. In order to prevent `last.log` files from being constantly copied to S3, the `copy-to-s3` task should run less frequently than the other task (the default is once every 4 hours).

You can run each maintenance task as a separate command, or you can use the `tshs do-tasks` command:

```
tshs do-tasks [all] [copy-shards] [remove-deleted] [perform-import]
[move-to-s3] [copy-to-s3] [all-not-s3-copy]
```

Generally it is recommended to use the `tshs do-tasks all` or `tshs do-tasks all-not-s3-copy` commands which will start all maintenance tasks at once. Use `all-not-s3-copy`, which omits the `copy-to-s3` task, to avoid too frequent backups. The advantage of using the `do-tasks all` is that new tasks that may be added to future versions of TSHS will automatically be executed.

In order to run maintenance tasks regularly you can start `tshs` in the daemon mode with the `-start` option, and use the `repeat` command to execute a command or list of commands separated by `and`.

By default, `tshs` is setup as a service to run as follows:

```
tshs repeat 60 do-tasks all-not-s3-copy repeat 14400 tshs do-tasks all
```

Which means that maintenance tasks except copy will be run once a minute (60 seconds), and the copy task which does a backup of the `last.log` files will be run every 4 hours (14400 seconds).

A number of options allow you to control how maintenance tasks are run:

- max-threads=<number>** Specifies the maximum number of threads to be started by a command. By default, the maximum number of threads is 10. This is the maximum number of threads that will run, no matter how many tasks are started. Note that this does not include the threads used to upload files to S3 as specified using the `MaxUploadThreads` parameter.
- pause-on-error=<seconds>** Specifies the time in seconds to pause after an error occurs during a maintenance task. The default is 2 minutes. When running in daemon mode, `tshs` ignores this option.
- retries=<number>** The number of times to retry if an error occurs during a maintenance task. Set to 'unlimited' if you want `tshs` to retry indefinitely. The default is 0, which means that the task quits immediately if an error occurs. When running in daemon mode, `tshs` ignores this option.
- time-limit=<seconds>** Specifies the time limit in seconds for running maintenance tasks. `tshs` will stop running the tasks after the specified time, whether the tasks are finished or not. The default is 0, which means unlimited. When a task is restarted it will continue from where it left off so you do not lose anything by stopping a task and restarting it again later. Use this parameter to prevent tasks from running during high load times when it could disturb normal operation.
- node-affinity=<node-id>** This option tells `tshs` to only transfer data from a specific storage node. This option may be used if you have a `tshs` service running on each storage node. Such a configuration reduces the amount of network traffic when data is transferred between nodes, or to and from S3 storage.

These options may be specified on the command line, or placed in the `tshs` options file: `/etc/tshs.conf`, which is consulted by the `tshs` background service. When running in daemon mode, errors and other messages are written to the `tshs` log file, which is `/var/log/tshs.log` by default.





## UPGRADING THE TEAMDRIVE HOST SERVER

### 12.1 General Upgrade Notes

There are two basic approaches to updating a TeamDrive Host Server: **in-place**, by replacing the software with a newer version on the live system, or starting a **new instance and migrating the configuration** and data (MySQL Database and Space Volumes) to the new instance.

For older installations, performing a migration to a freshly installed instance might be the better approach, to get rid of accumulated “cruft” and to start from a clean slate. In case the current system is still running a 32-bit installation, moving to a 64-bit system is required, as newer versions of the Host Server **no longer support 32-bit environments**.

Updating requires a service interruption, as the Host Server components (e.g. the Apache HTTP Server) need to be stopped while the update is in progress. Short downtimes usually pass unnoticed by the TeamDrive Clients, they will simply try again after a short waiting period. Local Client operations can continue.

The Host Server-specific MySQL Databases and Space Volumes are the two crucial pieces of data that need to be preserved during updates. Take backups prior to performing an update and *verify they worked correctly*. In case of an in-place upgrade, both the databases and Space Volumes can be taken over “as is”. When performing a migration to a new instance, the databases and volumes need to be copied or moved to the new host.

Updates between different Host Server versions (e.g. from 3.0.011 to 3.0.013) usually require changes to the MySQL table structures. Starting with version 3.0.013, these changes are applied automatically when starting the service after updating. Reversing these changes (e.g. reverting to the previous version) requires going back to the previous backup, there is **no automatic roll-back of changes to the database/table structures**.

Starting with version 3.0.013, updates to a new build (e.g. from 3.0.013.0 to 3.0.013.1) can be performed using yum/RPM. Updating from older versions requires manual intervention, as the installations were performed without automatic package management.

### 12.2 In-place Upgrading Version 3.6 to a Newer Build

---

**Note:** To enable the 3.7 TeamDrive Hosting Server yum repository, you need to download the updated `td-hostserver.repo` file and place it into the directory `/etc/yum.repos.d/`, e.g. by using `wget`:

```
[root@hostserver ~]# wget -O /etc/yum.repos.d/td-hostserver.repo http://repo.  
→teamdrive.net/td-hostserver.repo
```

---

The use of RPM packages makes updating from one build to another (e.g. from 3.6.0 to 3.6.1) a fairly straightforward and automatic process.

Usually, you can simply replace the existing packages while the service is running. The update performs an immediate restart of the services (`httpd` and `td-hostserver` automatically):

```
[root@hostserver ~]# yum update td-hostserver
```

Follow now the steps in the next chapter to stop the services, execute the database update to version 3.7 and start the services again.

To enable the new Point-in-Time recovery functionality, log in to the Administration Console and set `SnapshotsEnabled` to `true` as described in (see *Snapshot Backups* (page 43)). Restart the services `httpd`, `td-hostserver` and and in case of using a S3 compatible object store `s3d`.

Check the chapter `releasenotes-3.7` for the changes introduced in each build.

## 12.3 In-place Upgrading from 3.0.013 or 3.5 to 3.6

These instructions assume a default installation of the TeamDrive Host Server (version 3.0.013 / 3.5) on RHEL6 or a derivative distribution like CentOS 6 (64-bit) that was set up based on the Host Server installation instructions or using the TeamDrive Host Server Virtual Appliance for VMware.

The overall procedure is similar in all cases — we'll remove the old software components while maintaining the MySQL databases and Space Volumes, install the current versions of the Host Server packages and and migrate a few configuration settings by performing the following steps:

- Stop the Apache HTTP Server and TeamDrive Host Server processes
- Perform a backup of the Host Server's MySQL Databases
- Update the Host Server RPM package `yvva` and `td-hostserver`
- Update the configuration files and database
- Start the TeamDrive Hosting Service and Apache HTTP Server, check the log files for any errors
- Test the new setup with a local test client before allowing all user Clients to connect to the new instance again

The following paragraphs explain these steps in more detail.

### 12.3.1 Step 1) Stop the TeamDrive Services

As a first step, the currently running TeamDrive Hosting Services need to be shut down.

Start by stopping the Apache HTTP Server:

```
[root@hostserver ~]# service httpd stop
```

Next, stop the TeamDrive Hosting Service:

```
[root@hostserver ~]# service td-hostserver stop
```

and in case of using a S3 compatible object store, stop the `s3d` service:

```
[root@hostserver ~]# service s3d stop
```

### 12.3.2 Step 2) Create a MySQL Backup

After all TeamDrive Services have been stopped, you should now create a backup of the MySQL databases, e.g. using `mysqldump`:

```
[root@hostserver ~]# mysqldump -u root -p --force \  
--databases hostapilog pspace \  
| gzip > td-hostserver-mysql-$(date +%Y-%m-%d_%H.%M).sql.gz
```

### 12.3.3 Step 3) Install the new Host Server Software

Install the new Host Server components (td-hostserver and yvva) from the dedicated TeamDrive Host Server yum repository:

```
[root@hostserver ~]# wget -O /etc/yum.repos.d/td-hostserver.repo \
http://repo.teamdrive.net/td-hostserver.repo
[root@hostserver ~]# yum update td-hostserver yvva
```

Yum might show this warning:

```
warning: /etc/httpd/conf.d/td-hostserver.httpd.conf created as
/etc/httpd/conf.d/td-hostserver.httpd.conf.rpmnew
```

Please compare both files and take over new or missing values from td-hostserver.httpd.conf.rpmnew to the existing td-hostserver.httpd.conf.

Version 3.5 and later requires the following settings in the mysql configuration file /etc/my.cnf. Please add if not already set (the max\_connections=512 is the minimum value; it might be necessary to increase the value on your system depending on how many clients are connected to your server):

```
max_allowed_packet=4M
max_connections=512
```

Check the /etc/httpd/conf.d/ssl.conf and remove this block, if it exists:

```
RewriteEngine on
RewriteLogLevel 0
RewriteLog "/var/log/httpd/rewrite.log"
RewriteRule ^/admin$ /admin/ [R]
RewriteRule ^/admin(.*) /yvva/pla$1 [PT]
RewriteRule ^/pbas/pl_as/api/(.*)$ /yvva/api/$1 [PT]
RewriteRule ^/pbas/pl_as/pla/(.*)$ /primespace/admin/$1 [PT]
```

The block will be replaced by the **Include** statement at the end of the default <VirtualHost> section in /etc/httpd/conf.d/ssl.conf:

```
# Per-Server Logging:
# The home of a custom SSL log file. Use this when you want a
# compact non-error SSL logfile on a virtual host basis.
CustomLog logs/ssl_request_log \
    "%t %h %{SSL_PROTOCOL}x %{SSL_CIPHER}x \"%r\" %b"

Include conf.d/td-hostserver.httpd.conf.ssl
</VirtualHost>
```

### 12.3.4 Step 4) Update the database

Start the Yvva Runtime Environment's commandline shell yvva to perform the database updates. The updates will be directly executed when starting yvva. The amount of update steps depends on the existing version. When updating from the latest 3.5 version, you will see this output:

```
[root@hostserver ~] yvva
Welcome to yvva shell (version 1.4.1).
Enter "go" or end the line with ';' to execute submitted code.
For a list of commands enter "help".

161124 12:31:41 [Notice] *** Version 3.6: Adding column Space.DeleteTime
161124 12:31:41 [Notice] ALTER TABLE pspace.Space ADD DeleteTime TIMESTAMPTYPE
↪NULL AFTER ModifyTime
161124 12:31:41 [Notice] *** Version 3.6: Adding column Space.DeletedBy
```

```

161124 12:31:41 [Notice] ALTER TABLE pspace.Space ADD DeletedBy INT UNSIGNED
↪NULL AFTER DeleteTime
161124 12:31:41 [Notice] *** Version 3.6: Adding column Owner.RegServerName
161124 12:31:41 [Notice] ALTER TABLE pspace.Owner ADD RegServerName
↪VARCHAR(255) CHARACTER SET utf8 COLLATE utf8_unicode_ci NULL AFTER UserName
161124 12:31:41 [Notice] *** Version 3.6: Adding column Owner.RegPubMod
161124 12:31:41 [Notice] ALTER TABLE pspace.Owner ADD COLUMN RegPubMod INT
↪UNSIGNED NULL AFTER RegServerName
161124 12:31:41 [Notice] *** Version 3.6: Adding column Owner.
↪RegConnectStatus
161124 12:31:41 [Notice] ALTER TABLE pspace.Owner ADD COLUMN
↪RegConnectStatus VARCHAR(400) CHARACTER SET utf8 COLLATE utf8_bin NULL AFTER
↪RegPubMod
161124 12:31:41 [Notice] *** Version 3.6: Change collation of Owner.Email to
↪case-insensitive
161124 12:31:41 [Notice] ALTER TABLE pspace.Owner MODIFY Email VARCHAR(256)
↪CHARACTER SET utf8 COLLATE utf8_unicode_ci NULL
161124 12:31:41 [Notice] *** Version 3.6.1: Adding column Owner.RegDistCode
161124 12:31:41 [Notice] ALTER TABLE pspace.Owner ADD COLUMN RegDistCode
↪VARCHAR(20) CHARACTER SET utf8 COLLATE utf8_bin NULL AFTER RegServerName

RESTORE COMMANDS:
-----
To get help on restore commands, enter:

restore_help;;

>

```

You can close the `yvva` session by typing `quit` or pressing `Ctrl+D` on the `>` prompt.

### 12.3.5 Step 5) Start the Host Server Components

Now start the TeamDrive Hosting Service:

```

[root@hostserver ~]# service td-hostserver start
Starting TeamDrive Hosting Services: [ OK ]

```

Check the log file for any errors:

```

[root@hostserver ~]# less /var/log/td-hostserver.log

```

Next, start the Apache HTTP Server:

```

[root@hostserver ~]# service httpd start
Starting httpd: [ OK ]

```

Check the log files for any errors:

```

[root@hostserver ~]# less /var/log/httpd/error_log
[root@hostserver ~]# less /var/log/mod_ospace.log
[root@hostserver ~]# less /var/log/td-hostserver.log

```

And in case of using a S3 compatible object store, start the `s3d` service:

```

[root@hostserver ~]# service s3d start
Starting TeamDrive S3 Daemon: [ OK ]

```

In case of any errors, check the chapter troubleshooting for guidance.

### 12.3.6 Step 6) Log into the Administration Console

After the services have been started, try logging into the Administration Console and verify the settings.

Logging into the Administration Console with the `HostAdmin` user account. If you don't recall the password you used, see chapter *Changing an Admin User's Password* (page 10) for details on how to reset it.

### 12.3.7 Step 7) Enable the TeamDrive Hosting Service at System Boot

If the update was successful and the service is up and running, make sure it gets started automatically when the system reboots:

```
[root@hostserver ~]# chkconfig | grep td-hostserver
td-hostserver    0:off  1:off  2:off  3:off  4:off  5:off  6:off
[root@hostserver ~]# chkconfig td-hostserver on
[root@hostserver ~]# chkconfig | grep td-hostserver
td-hostserver    0:off  1:off  2:on   3:on   4:on   5:on   6:off
[root@hostserver ~]# chkconfig | grep httpd
httpd            0:off  1:off  2:on   3:on   4:on   5:on   6:off
```

And in case of using a S3 compatible object store:

```
[root@hostserver ~]# chkconfig | grep s3d
s3d              0:off  1:off  2:on   3:on   4:on   5:on   6:off
```

## 12.4 Migrating an Older Host Server Version to a 3.6 Instance

Please contact TeamDrive Systems for further information.



## TROUBLESHOOTING

Note that SE-Linux in the standard setup will prevent Apache from writing to the Host Server logs.

In addition, the firewall in the standard setup will block access to Apache.

### 13.1 List of relevant configuration files

**/etc/httpd/conf.d/td-hostserver.httpd.conf:** The configuration file that loads and enables the TeamDrive Host Server-specific modules for the the Apache HTTP Server:

- `mod_pspace.so`: this Apache module provides the actual Host Server functionality by accepting incoming data from the TeamDrive clients as well as delivering data to other clients upon request.
- `mod_yvva.so`: this Apache module is responsible for providing the web-based Host Server Administration Console as well as the Host Server API interface.

**/etc/logrotate.d/td-hostserver:** This file configures how the log files belonging to the TeamDrive Host Service are being rotated. See the `logrotate(8)` manual page for details.

**/etc/td-hosting.conf:** This file defines how the `td-hostserver` background service is started using the `yvvad` daemon.

**/etc/td-hostserver.my.cnf:** This configuration file defines the MySQL credentials used to access the `pspace` MySQL database. It is read by the Apache modules `mod_yvva` and `mod_pspace` as well as the `yvvad` daemon that runs the `td-hostserver` background tasks and the `yvva` command line client.

**/etc/yvva.conf:** This configuration file contains configuration settings specific to the Yvva Runtime Environment that are shared by all Yvva components, namely the `mod_yvva` Apache module, the `yvvad` daemon and the `yvva` command line shell.

**/etc/tshs.conf:** This configuration file defines a number of maintenance tasks performed by the `tshs` background service.

### 13.2 List of relevant log files

In order to debug and analyse problems with the Host Server configuration, there are several log files that you should consult:

**/var/log/td-hostserver.log:** The log file for the Yvva Application Server module which provides the web-based Host Server Administration Console and API. Consult this log file when you have issues with associating the Host Server with the Registration Server, errors when issuing API requests or problems with the Administration Console. You can increase the amount of logging by changing the Yvva setting `log-level` from `error` to `trace` or `debug` in `/etc/httpd/conf.d/td-hostserver.httpd.conf`:

```
<Location /yvva>
  SetHandler yvva-handler
  YvvaSet root-path=/opt/teamdrive/hostserver
  YvvaSet mysql-cnfile=/etc/td-hostserver.my.cnf
  YvvaSet log-file=/var/log/td-hostserver.log
  YvvaSet log-level=error
</Location>
```

After changing these values, you need to restart the Apache HTTP Server service using `service httpd restart`.

This log file is also used by the `td-hostserver` background task. Check this one to verify that background tasks are being processed without errors. The log file location can be configured by changing the file name passed to the `log-file` option in the configuration file `/etc/td-hosting.conf`. The log level can be increased by changing the default value `error` for the `log-level` option to `trace` or `debug`. Changing these values requires a restart of the `td-hostserver` background process using `service td-hostserver restart`.

**/var/log/mod\_pspace.log:** This log file contains error messages related to the `mod_pspace` Apache module, particularly when using an compatible object store or TSHS. It needs to be writable by the user that the Apache HTTP Server runs under (`apache` by default). The log file location is configured by the server setting `ModuleLogFile` and the amount of logging can be changed by adjusting the server setting `ModuleLogLevel` via the Host Server Administration Console. The value defines the maximum level of logging of messages logged: 1 = Error, 2 = Warning, 3 = Notice, 4 = Trace, 5 = Debug. Changing these values requires restarting the Apache HTTP Server.

**/var/log/httpd/:** The Apache HTTP Server's log files (e.g. `error_log`) might also contain additional relevant error messages (e.g. from `mod_pspace`) that should be checked. The amount of logging is affected by the `ModuleLogLevel` setting described above.

**/var/log/tshs.log:** This log file contains errors and other messages generated by the `tshs` background service. The log file location and amount of output are defined in file `/etc/tshs.conf`, via the options `log-file` and `log-level`. Possible values in the order of verbosity are `protocol`, `error`, `warning`, `trace`, `debug`. The default is `warning`.

**/var/log/s3d.log:** This log file is written by the TeamDrive S3 daemon `s3d` and provides log messages and errors specific to the `s3d` background service. The log file location is defined in the init script `/etc/init.d/s3d`.

## 13.3 Enable Logging with Syslog

As outlined in list of relevant log files, the TeamDrive Host Server logs critical errors and other notable events in various log files by default.

Starting with Host Server version 3.5 and Yvva 1.2, it is now possible to redirect the log output of some server components to a local `syslog` instance as well.

---

**Note:** Please note that other components of the TeamDrive Host Server, e.g. `mod_pspace`, `s3d` or `tshs` currently do not provide `syslog` support. This limitation may be lifted in future versions of the TeamDrive Host Server software.

---

Syslog support is an essential feature for auditing, security and/or compliance reasons, as it allows you to funnel all log messages into a centralized `syslog` server.

This makes it easier to monitor the logs for critical events or errors and prevents tampering with the log files in case of a security breach. It also helps to maintain control over the disk space utilization on the server, as growing log files can't accidentally fill up the file system.



To enable syslog support, the log file name in the `log-file` setting has to be replaced with the keyword `syslog`. Optionally, a custom process identifier can be supplied, by appending it to the `syslog` keyword, using a colon as the separator, e.g. `log-file=syslog:my_process_identifier`. If not used, the default process identifier will be used, which is the name of the program executable.

To enable syslog support for the Yvva-based `td-hostserver` background service, edit the `log-file` setting in file `/etc/td-hosting.conf` as follows:

```
log-file=syslog:td-hostserver
```

You need to restart the `td-hostserver` background service via `service td-hostserver restart` in order to activate this change. If the `log-level` is set to `debug` you will now see log messages appearing in `/var/log/messages`:

```
Jun 23 11:57:33 localhost td-hostserver: notice: yvvad startup
Jun 23 11:57:33 localhost td-hostserver: notice: Using config file:
/etc/td-hosting.conf
Jun 23 11:57:33 localhost td-hostserver: notice: No listen port
Jun 23 11:57:33 localhost td-hostserver: notice: yvvad running in repeat 60
(seconds) mode
```

To enable syslog support for the Host Server API and Administration Console, edit the `YvvaSet log-file` setting in file `/etc/httpd/conf.d/td-hostserver.httpd.conf`:

```
YvvaSet log-file=syslog
```

You need to restart the Apache HTTP Server via `service httpd restart` in order to activate this change. If the `log-level` is set to `debug` you will now see log messages appearing in `/var/log/messages`:

```
Jun 23 12:06:04 localhost mod_yvva: notice: mod_yvva 1.2.1 (May 21 2015
11:00:12) startup OK
```

## 13.4 Tracing Client Accesses to a Single Space

For debugging issues with a specific Space, it might be useful to enable more verbose tracing of activity between the Host Server and the TeamDrive Clients accessing this Space.

For this purpose, access to that Space can be traced by providing the Space's ID to the option `watched_space_id` in `/etc/httpd/conf.d/td-hostserver.httpd.conf` as follows:

```
<Location /primespace>
  SetHandler pspace-handler
  MySQLCnf /etc/td-hostserver.my.cnf

  watched_space_id <space ID>

  # Necessary to ignore the extra Range-header
  # (see Range-header note in the documentation)
  RequestHeader unset Range
</Location>
```

Restart the Apache HTTP Server with `service httpd restart`. Any activity on the selected Space will now be logged into the log file `/var/log/mod_ospace.log`.

**Note:** Remove this option and restart the Apache HTTP Server once you've finished analyzing the problem, to avoid uncontrolled growth of the log file.

## 13.5 Common errors

### 13.5.1 Web Installation: “500 Internal Server Error”

This error can be triggered by several error conditions. Check the log file `/var/log/td-hostserver.log` for details.

---

**Note:** If there is **no error in the log**, then the problem may be that SELinux is still enabled. Please see: `disable_selinux` for details.

---

Some common errors include:

```
[Error] -12036 (2002): Can't connect to local MySQL server through socket
'/var/lib/mysql/mysql.sock' (25)
[Error] "startup.yv" (80)
```

The local MySQL Server’s socket file can’t be opened. This could either be a permission problem, or the MySQL Server is simply not available. Check that MySQL is actually up and running (e.g. by running `service mysqld status`) and restart it, if necessary. If the error persists, check the MySQL error log file (usually `/var/log/mysqld.log`) for hints.

Similarly, an error like the following one indicates that a remote MySQL Server might not be answering (e.g. because of a firewall rule or because it’s not running):

```
[Error] -12036 (2003): Can't connect to MySQL server on
'mysql.yourdomain.com' (107)
[Error] "startup.yv" (80)
```

If you see `Access denied` errors like the following one:

```
[Error] -12036 (1045): Access denied for user 'teamdrive'@'localhost' (using
password: YES)
[Error] "startup.yv" (32)
```

Either the username or password used to connect to the MySQL Server are wrong. Double check that the MySQL username and password provided in `/etc/td-hostserver.my.cnf` are correct, e.g. by trying to connect to the MySQL server using these credentials with the `mysql` command line client.

If you see the following error when connecting to a remote MySQL Server:

```
[Error] -12036 (1130): Host 'regserver.yourdomain.com' is not allowed to
connect to this MySQL server
[Error] "startup.yv" (80)
```

Check the TeamDrive MySQL user’s privileges on the remote MySQL server, e.g. by running `SHOW GRANTS FOR `teamdrive`@`regserver.yourdomain.com``; and make sure that this user is allowed to connect to the MySQL server from the Registration Server’s host.

### 13.5.2 Errors When Registering the Host Server

If the Host Server Registration fails, check `/var/log/td-hostserver.log` on the Host Server as well as `/var/log/td-regserver.log` on the Registration Server for hints (`/var/log/pbt_mod.trace` for Registration Server versions before version 3.5). See the Troubleshooting chapter in the Registration Server Installation Manual for details.

### 13.5.3 MySQL Errors When Upgrading From an Older Host Server Version

If you observe Access denied or Unknown database errors from the MySQL server like the following ones after starting the updated TeamDrive Host Server using an older MySQL table structure:

```
[Note] DROP DATABASE pbpg;
[Error] -12036 (1044): Access denied for user 'teamdrive'@'localhost' to
database 'hostapilog'
[Error] "plsetup.pbt" P1Setup:upgradeSettings(328)
[Error] "plsetup.pbt" P1Setup:setupDatabase(14)
[Error] "plsetup.pbt" (506)
```

Unknown database:

```
[Error] -12036 (1049): Unknown database 'hostapilog'
[Error] "plsetup.pbt" P1Setup:upgradeSettings(328)
[Error] "plsetup.pbt" P1Setup:setupDatabase(14)
[Error] "plsetup.pbt" (506)
[Error] "pl_shared.pbt" (2)
```

Double check that the hostapilog database actually exists and that the teamdrive user has the required privileges to access it.

Create the database using `CREATE DATABASE hostapilog;` and grant the required privileges using `GRANT ALL PRIVILEGES ON `hostapilog`.* TO 'teamdrive'@'localhost';`. Restart the TeamDrive Service again using `service td-hostserver restart`, it should now conclude the schema conversion.

If you observe a Can't connect to local MySQL server error like the following one in `/var/log/httpd/error_log`:

```
[notice] mod_ospace 1.6.17 Loaded; Build May 6 2015 12:42:39;
Crash-Reporting-Disabled
[error] Failed to boot Admin API: MySQL 2002:
Can't connect to local MySQL server through socket
'/var/lib/mysql/mysql.sock' (2)
```

or in `/var/log/td-hostserver.log`:

```
[Error] -12036 (2002): Can't connect to local MySQL server
through socket '/var/lib/mysql/mysql.sock' (2)
```

Double check that the MySQL Server is up and running and that the socket configuration setting in the `[mysqld]` group in `/etc/my.cnf` matches the one in `/etc/td-hostserver.my.cnf`.

The default value is `/var/lib/mysql/mysql.sock`. If the value in `my.cnf` is different, e.g. `/tmp/mysql.sock`, we suggest to revert back to the default value there instead of changing it in `td-hostserver.my.cnf` (unless you have an explicit reason to change the default socket path, of course).

Restart MySQL and the TeamDrive Hosting Services after changing this value.

### 13.5.4 Admin Console: Clicking on “Host” Results in a “500 Internal Server Error”

If you observe an error message like the following when clicking on **Host** in the Host Server Administration Console:

```
500 Internal Server Error
ERROR -1: TshsMain: void CSDBConn::connect(CSDB.cc:1116) MySQL 1044: Access
denied for user 'teamdrive'@'localhost' to database 'tshs_admin'
```

Or:

```
500 Internal Server Error
ERROR -1: TshsMain: void CSDBConn::connect(CSDB.cc:1116) MySQL 1049: Unknown
database 'tshs_admin'
```

You likely changed the setting `TSHSEnabled` to `True`, but did not configure the MySQL settings for accessing the `tshs_admin` database in `/etc/td-hostserver.my.cnf`.

If you changed the setting by accident, simply set `TSHSEnabled` back to `False`.

Otherwise, consult the chapter *TeamDrive Scalable Hosting Storage* in the Team Drive Host Server Administration Guide for details on how to enable and configure TSHS properly.

### 13.5.5 “Duplicate key” MySQL errors when updating the database

If you observe “Duplicate key” errors in the `Traffic` or `Owner` tables when upgrading these to the latest schema version, you first need to manually remove the duplicates via the MySQL client or another tool like MySQL Workbench. Older versions of the Host Server database schema did not have `UNIQUE` constraints on some columns, which caused the creation of duplicate entries. For the `Traffic` table, this usually only affects older traffic accounting information that can safely be removed.

Duplicates in the `Owner` table are likely caused by user names or email addresses that refer to the same user account, but using different capitalization. In this case it helps to cross-reference the affected users with their information in the Registration Server Database - likely one of these accounts has not been actively used and can be deleted. Please contact [support@teamdrive.net](mailto:support@teamdrive.net) if you need assistance in resolving these conflicts.

### 13.5.6 Admin API Error: MySQL 1040: Too many connections

On a busy server, you might observe one of the following error messages in the Apache HTTP Server’s error log file from time to time:

```
[error] Failed to boot Admin API: MySQL 1040: Too many connections
[error] [client xxx.xxx.xxx.xxx] (500)Unknown error 500: Admin API Error:
MySQL 1040: Too many connections
```

In `/var/log/td-hostserver.log` you might observe a similar error:

```
[Error] -12036 (1040): Too many connections
[Error] "startup.yv" (80)
```

This error indicates that the number of child processes spawned by the Apache HTTP Server (e.g. when many TeamDrive Clients attempt to connect to the Host Server concurrently), causes the MySQL Server to run out of threads for handling the incoming database connections.

By default, the MySQL Server is configured to accept 151 concurrent connections. Each Apache child process can establish up to two MySQL connections (one for `mod_ospace` and one for `mod_yvva`, depending on what kind of requests it needs to serve). Therefore, the maximum number of connections should be adjusted to be at least 1.5 times the maximum number of child processes spawned by the Apache HTTP Server (defined by the `MaxClients` directive in the Apache HTTP Server configuration file `/etc/httpd/conf/httpd.conf`).

The value can be changed by adding the system variable `max_connections` to the `[mysqld]` configuration group in the MySQL Server configuration file `/etc/my.cnf`, e.g.:

```
[mysqld]
datadir=/var/lib/mysql
max_allowed_packet=4M
max_connections=350
socket=/var/lib/mysql/mysql.sock
user=mysql
```

You need to either restart the MySQL server in order to apply this change, or change the value at run-time, by running the following SQL statement as the MySQL root user:

```
mysql> SET GLOBAL max_connections=350;
```

Keep in mind that increasing the maximum number of connections also increases the memory requirements of the MySQL Server. For more details, please consult the MySQL Server and Apache HTTP Server documentation:

<https://dev.mysql.com/doc/refman/5.6/en/too-many-connections.html>

[https://httpd.apache.org/docs/2.2/mod/mpm\\_common.html#maxclients](https://httpd.apache.org/docs/2.2/mod/mpm_common.html#maxclients)

<http://fuscata.com/kb/set-maxclients-apache-prefork>



## RELEASE NOTES - VERSION 4.X

### 14.1 Change Log - Version 4.0

#### 14.1.1 4.0.3 (2022-06-09)

- Space global ID's generated must be 32 bytes long. This is required by older TeamDrive clients.

#### 14.1.2 4.0.2 (2022-03-09)

This release also includes a number of security improvements, please contact TeamDrive for further details.

- TeamDrive Protocol (TDP) v1 will be automatically disabled for Depots that are not accessed by TeamDrive 3 clients for 6 months (HOSTSERVER-828).  
TDP v1 can now also be manually disabled for a Depot in the Admin Console.
- Updated MariaDB connector (native MySQL client libs) (HOSTSERVER-839).
- Fixed a bug which lead to “provider users” referenced from the history to be marked as deleted.
- Ensure that an error is written to the various Host Server logs if a database upgrade is required (HOSTSERVER-843).
- Fixed a bug which caused an exception of the form: “Type mismatch in delete file attempt: ...”, and prevented deletion of a space on S3 storage.
- If initialisation of S3 fails in apache module then the TDP v3 protocol will now no longer return an error on every request. Instead an error is only returned when access to S3 is actually required (HOSTSERVER-849). This means that uploading BLOBs and downloading recently uploaded BLOBs of a space still work, if S3 is offline.

#### 14.1.3 4.0.1 (2021-10-08)

This is a security update.

- A number of security issue have been fixed, please contact TeamDrive for further details.
- Logging functions now encode r and n characters to prevent “Log Poisoning” (HOSTSERVER-835).

#### 14.1.4 4.0.0 (2021-08-31)

The Host Server 4.0 requires the YVVA runtime version 1.5.8 or later.

Note that as of version 4.0, the database must now be upgraded manually using the `upgrade_now; ;` command on the YVVA console (see *Step 4) Update the database* (page 71)).

## Host Server Functionality

- Set security headers in Apache configuration (HOSTSERVER-821).
- The Host Server will now pause up to 5 seconds before sending the reply to the client if the download limit is exceeded, see `downloadlimit` (HOSTSERVER-808).

If the limit is exceeded, the Host Server will send an email to all System Administrators that receive emails. This notification is sent at most, once per hour.

- Depot overflow behavior has been changed significantly in 4.0 (HOSTSERVER-795)

The Host Server now allows upload of files to continue when the depot of a space is over the 100% limit. However, files uploaded in this time may not be downloaded by clients. Only once the depot is below the 100% limit are those files released for download. Files uploaded before the overflow may always be downloaded.

Depots now have an “overflow limit” and a “maximum overflow upload rate” which apply when the depot is full. This value depends on the actual depot storage limit as follows:

Depot limit	Overflow limit	Max Upload Rate
< 3 GB	10 GB	1 GB per day
< 120 GB	50 GB	2 GB per day
>= 120 GB	100 GB	4 GB per day

When a depot reaches the depot limit plus the overflow limit, the depot is “frozen”. When a depot is frozen upload and download of files is no longer permitted. This means that the only way to “unfreeze” a depot is to increase the depot storage limit.

In the frozen state deleting files, snapshots or emptying the trash may not work because of file uploads that may be queued before these operations prevent the operations from being synchronised.

A number of emails are sent to the owner of the depot, the managers of the account that owns the depot, and to certain administrators of the Host Server. In the Admin Console you can mark an Admin User as a receiver of “Email Notifications”. By default, this is enabled for all administrators.

Emails are sent when the storage exceeds 20% and 50% of the overflow limit, and when it exceeds 100% of the overlimit an email is sent to inform users and managers that the depot has been frozen.

Note that these emails are in addition to the warning emails send when the depot is 80% and 100% full, however these emails are not sent to the Host Server administrators.

- The Host Server nows sends a notification emails to the depot owner, and managers of the account that owns the storage usage exceeds 80% and 100% of the storage limit (HOSTSERVER-768).
- The Host Server also sends notification emails if the depot network traffic reaches 80%, and when traffic exceeds the limit (HOSTSERVER-793). Emails are sent to the depot owner and to managers of the account that owns the depot.

The 100% usage notification is also sent to Host Server administrators that have been selected to receive email notifications.

- Added functionality to recalculate the size used by a space, on disk and in the cloud (HOSTSERVER-738).

Buttons are provided in the Admin Console to initiate the calculation of disk usage for a space and for all spaces in a depot.

After a space has been restored, recalculation of disk usage is automatically scheduled.

Depot size recalculation is triggered if a depot exceeds 100% storage usage, and the size of the depot has not been recalculated in the last 180 days.

- This version implements Amazon Signature Version 4. This can be enabled by adding the option `UseSignatureV4=True` to the `S3Options` setting (HOSTSERVER-766).

Note that this signature type only works for Amazon (and fully Amazon compatible) object stores, Azure and OpenStack still use the Version 2 signatures.



- Added the `S3Region` setting which determines the region used in Amazon Version 4 signing process. By default the value “eu-west-1” is used.

The region must be set according to the following mapping: [Amazon Regions and Endpoints](#)

- The Host Server will now automatically delete spaces in a depot to reduce disk usage, when the limit of a depot is exceeded by a certain amount (HOSTSERVER-759). See *Depot Overflow and Automatic Space Reduction* (page 47) for details.

Two settings have been added to support this feature: `EnableSpaceReductionProcess`` and ```AllowAutoDeleteSpaces` (see `resource_management_settings` for details).

Spaces will not be deleted if the depot has been active within the last 6 months.

- The Apache module and the `s3d` service now check the database version. If the database structure is not up-to-date the Apache module generates an error, but will continue normally as soon as the database is update. The `s3d` quits if the database version is not he require version, currently this is version 3.7 level.
- Added `TransferConnection` setting which is used to support the transfer of the Host Server Object Store to a different service provider (see `transferconnection`) (HOSTSERVER-771).
- Added the `UseIPWorks` setting (default: `False`). Set this value to `True` in order to use the IPWorks-based cloud access implementation.
- Added various binary hardening measures. Maximum POST request size for API calls is is now 10 MB.

## Administration Console

---

**Note:** Please clear the browser cache after the server update.

---

- You can now specify whether snapshots should be enabled or disable for a new space on the depot level. Here you can choose between always enabling or disabling snapshots for spaces created in the depot, or you can make it depending on the value of the `EnableSnapshotsByDefault` setting. This is the default (HOSTSERVER-785).

Note that changing this value does not change whether snapshots are enabled or not for existing spaces.

- Using “Set Space Status” and “Unset Space Status” on the space depot page, you can now set and remove a status from all spaces in a depot. The status’ that may be set/removed are: “Disabled”, “Readonly”, “Deactivated for maintenance” and “Deactivated by provider” (HOSTSERVER-761).
- On the Space Depot page the “Recalc Depot Size” button can be used to initiate the recalculation of the sizes of all spaces in the depot. This process is performed in the background and may take a while.
- On the Space Details page you can use the “Recalculate Disk Usage” button to initiate recalculation of the disk space used. This process is performed in the background and may take a while.
- On the Space Depot page, the “Restore Spaces” button may be used to undelete all spaces in the depot. This function can be used after restoring the space of a depot from backup.

If the space directory does not exist on disk, then the space cannot be restored, and this will cause the process of restoring spaces to stop.

An empty space directory will be restored as an empty space. After restoring a space, recalculation of the disk space of the space will be initiated.

- It is now possible to set a volume space limit to 0, which means unlimited.
- The Admin Console can now “rollback” a failed restore snapshot attempt (HOSTSERVER-807). This case is clearly shown in the Admin Console, if the space is in the “Restoring” state, and a notice on the space indicates that a restore to snapshot is in progress. If this operation is not completed within a few minutes it is OK, to press the “Space Restored” button, to undo any changes to the space log files.
- The Object Store key (setting `S3SecretKey`) is no longer shown completely in the Admin Console for security reasons (HOSTSERVER-813).



## RELEASE NOTES - VERSION 3.X

### 15.1 Change Log - Version 3.7

#### 15.1.1 3.7.11 (2021-02-18)

- Fixed a bug in the cleanup code of s3d, that is used after space rollback. A directory object returned from S3 was not correctly handled.
- The Apache module (`mod_ospace`) will now retry S3 startup (object store access) if this fails on startup of the module (HOSTSERVER-781).
- Updated jquery.js version to 3.5.1 (HOSTSERVER-788).
- Added download logging (HOSTSERVER-787). This functionality can be used to limit the number of downloads of a file, from a certain client device in a certain amount of time. Published files are not effected by this limit.

If the download quota is exceeded, the Host Server returns a `HTTP_TOO_MANY_REQUESTS (429)` error.

New settings (`EnableDownloadLogging`, `DownloadLimit`, `DownloadLogGrouping`, `DownloadLogRetention` and `DownloadRatePeriod`) allow this to be configured globally for the Host Server.

Download logging can also be enabled at the Depot level by setting a “download limit”. This value overrides the global `DownloadLimit` setting. See `download_logging` for details.

In the Admin Console the download log can be viewed and queried from the “Log Files” menu item.

#### 15.1.2 3.7.10 (2020-05-15)

A number of changes have been made to prevent the publishing of a web-site using the publish file functionality (HOSTSERVER-770). This includes:

- Added the `EnableDirectLink` setting which makes it possible to disable the direct link feature (`dl=1`).
- Added the `ForceDownloadList` setting: This a list of content types and file endings that force a download in place of displaying the file in the browser.
- Added the `PublicRewritesInstalled` setting which indicates that certain re-write rules have been added to the Host Server, which allow the TeamDrive client to generate public URLs that vary in the first component depending on the space (see `publicrewritesinstalled`).

#### 15.1.3 3.7.9 (2019-07-19)

- The S3 server name (setting `S3Server`) may now be specified as a URL, not just a domain. This allows you to set the protocol to HTTPS, and specify an alternative port (HOSTSERVER-767).

If a protocol is specified in the URL, then this overrides the value of the `S3RedirectProtocol` setting.

- Fixed the setting `S3RedirectProtocol`, which was ignored by the Host Server apache module (`mod_pspace`).

### 15.1.4 3.7.8 (2019-03-29)

- `S3Daemon`: Set `CURLOPT_NOSIGNAL` in order to prevent crash which occurs when libcurl receives a signal due to a timeout in domain lookup
- Set `yvva` dependency to 1.4.6

### 15.1.5 3.7.7 (2019-02-26)

- A unique index has been added to the `Owner.UserName` field where it was missing (HOSTSERVER-763).
- If `HttpsUsedByPublish` is set to `True`, the Host Server will now return an error when trying to access a published file using HTTP (instead of HTTPS) (HOSTSERVER-762).
- An error occurred when adding/removing a large number of users to/from a depot. This is due to field size limitations in the `RepositoryChanges` table. Excessively long user lists are now truncated, and the suffix: `”, ... and N others”` is added (REGSERVER-1379).
- The `“getdepotdata”` API call was incorrectly returning the `“&nbsp;”` HTML entity in the `<changelist>` details.
- Fixed a bug when setting the owner of a repository, if the repository had no a history entry was not created.
- Added timeouts for all S3 operations. The connection timeout is set to 2 minutes, and the timeout for the entire S3 operation is set to 30 minutes (HOSTSERVER-758). This is to prevent the background task from hanging in the request to get the S3 logs.
- Returning data from encrypted files could hang in `Tdp3File::send_file()` if there was an error on the channel (HOSTSERVER-760).

### 15.1.6 3.7.6 (2018-10-22)

- Fixed a bug in the calculation of Space disk usage when correcting spaces that have a negative disk usage. The bug resulted in a overflow error being thrown by the `“Check Spaces with Limit”` auto task (HOSTSERVER-757).
- Fixed a bug when deleting an owner (user that has been deleted on the Registration Server): if the user was a user of a depot, then: either (1) the user was not removed or (2) a repository history entry was not inserted.

### 15.1.7 3.7.5 (2018-10-11)

- Spaces marked as having a data retention period may not be deleted over the API (HOSTSERVER-751).  
These spaces must either be deleted using the TeamDrive client, or on the Host Server Admin Console. Depots containing spaces with a data retention period are also subject to this restriction.
- Deleting a depot on the Admin Console will now delete all spaces in the depot.
- Undeleting all spaces and restoring all spaces belonging to a depot is now possible. When a depot contains deleted spaces the button `“Undeleted Spaces”` and `“Spaces Restored”` appear in the Admin Console on the depot page. Note that if the depot has been deleted, then you must undelete the depot first (HOSTSERVER-726).

An error will occur if you click `“Spaces Restored”`, and not all spaces in the depot have been copied back to an active volume on the host. In this case, the restore of some spaces may be complete while other remain deleted.

As before, undeleted and restore are possible at the space level, however, this will not be allowed if the repository of the space has been deleted.

NOTE! The Admin Console setting: `ShowDeletedObjects` must be set to true in order to see depots and spaces that have been deleted.

- Added `SpaceDeletionDelay` (Resource Management) setting which specifies the time between a space being deleted and it actually being removed from disk (HOSTSERVER-727). During this time the space can be undeleted.
- Added `AllowedLoginIPList` (Admin Console) setting which can be used to restrict login to the Admin Console to certain IP addresses (HOSTSERVER-723).
- HTML templates can now be customised by setting a header and a footer HTML “snippet” (HOSTSERVER-729) at the depot level.

Note that the placeholders `[[HEADER]]` and `[[FOOTER]]` have been added to the relevant HTML templates for this purpose.

The global settings: `DefaultTemplateFooter` and `DefaultTemplateHeader` are used as default values if nothing is specified for a depot.

- HTML template can use conditional sections (). This have the following form:

```
[[IF:<placeholder>]] ... [[ENDIF:<placeholder>]]
```

and

```
[[IFNOT:<placeholder>]] ... [[ENDIF:<placeholder>]]
```

where `<placeholder>` may be any valid placeholder: `HEADER`, `FOOTER`, `FILE-NAME`, `ERROR-MESSAGE`, `ERROR-CODE` and `PUBLIC-URL`.

The `IF` sections are displayed if the specified placeholder is not empty and non-zero (in, the case if `ERROR-CODE`). `IFNOT` sections are displayed if the placeholder value is empty or zero.

- Operations that append to log files now return the log offset of the position after the block written (HOSTSERVER-740).
- The Host Server now supports at rest encryption of public files.

The new HTML template: “`decryption-failed.html`”, will be returned if the public URL does not contain a correct or valid decryption key.

- The Host Server now supports “shorted URLs” for public files. A short URL may be requested before upload of a public file begins (HOSTSERVER-722).

A new HTML template has been added: “`upload-incomplete.html`”. This template is returned if upload of a public file has been started, but is not yet complete. This is necessary because, in the case of large files, the TeamDrive Client may make the public URL available before the upload is complete.

---

**Note:** For short URL public files to work correctly, you must remove the `action="..."` attribute from the `<form>` tags, in the “`enter-password.html`” and “`password-wrong.html`” templates. The default templates have already been updated.

---

- Published files are now encrypted at rest. The key must provided in the URL on upload and download (HOSTSERVER-732).

### 15.1.8 3.7.4 (2018-07-17)

- Fixed crash in background task when a Registration Server was not available during synchronisation of owner data (HOSTSERVER-720).
- The “`getdepotdata`” API call now returns a `<flags>` tag which may include the `restrict-access` flag value (see `getdepotdataRef` for details).

- The “createdepot” API call no longer automatically creates a “contract number” for a depot which starts with “WEB#”.
- Fixed a bug that prevented the synchronisation of data with foreign Registration Server. The error in log was: “RROR -24903 (0): Authorization failed: device 99999 not found” (HOSTSERVER-725).
- When moving spaces from one depot to another, then disk usage and traffic was not always recalculated correctly (HOSTSERVER-731).
- Under certain circumstance published files that were part of a snapshot were not deleted after expiry, although access to the file was prevented (HOSTSERVER-733).
- Under some circumstance the Host Server set the “Traffic limit exceeded” flag, even when the `EnforceTrafficLimit` setting was set to `False` (HOSTSERVER-735).
- The Host Server now records the name of the user that made changes to a depot. Previously this information was not always available as it was placed in the comments. This function requires the use of Registration Server version 4.0 or later (HOSTSERVER-736).

### 15.1.9 3.7.3 (2017-11-01)

- Improved the reporting and logging of connection errors that may occur when the Host Server contacts the Registration Server.
- During Host Server Setup it is now possible to specify a proxy to use in order to contact the Registration Server. The `NoProxyList` setting must be specified after setup, if required.
- Improved input checking on setup of the Host Server. The Registration Name may not contain in special characters. Domain Names may not contain any spaces, and must include at least one ‘.’ character (HOSTSERVER-715).

- The Host Server will now prevent access to a Depot if all users are removed from the access list. Previously, Depots reverted to unrestricted access when the last user was removed from the access list.

The Depot users in the access list are now displayed in the Admin Console. Only the Depot owner and users in this list are allowed to create Spaces in the Depot. However, users not in the list are not prevented from using existing Spaces in the Depot.

- Deleting a Depot in the Admin Console now works the same as deleting a Depot via the API: the Depot is simply marked as deleted (HOSTSERVER-712).

If the setting `ShowDeletedObjects` is `False`, then Depots marked as deleted will not be visible in the Depot list. However, such Depots can be reached by clicking on the Depot link in a Space belonging to the Depot.

Note that deleting a Depot currently just prevents new Spaces from being created in the Depot. Existing Spaces are still accessible.

- Moved index on `SpaceID`, `MetaType` from `MetaData` to `MetaDataOptions` table. This index was previously created on the wrong table (HOSTSERVER-716).
- Added support for “If-Modified-Since” header. If sent, and BLOB data has not been modified since the specified time, the server will now send a “304 Not Modified” result. This is in order to support caching proxies (HOSTSERVER-709).
- Added `NonCachingProxies` setting. This is a list of the host names or pseudonyms of proxies that are downstream from the Host Server but do not cache any data (HOSTSERVER-711).
- Version 3.7.3 requires YVVA runtime version 1.4.4.

### 15.1.10 3.7.2 (2017-08-14)

- The TPD v3 call “restsnap” will now delete all meta data created for the Space after the last modify time of the snapshot (HOSTSERVER-708).

- Fixed a database deadlock in TDP v3 call “addmeta” (HOSTSERVER-707).
- Moved `EnableProxyCaching` to “Client Settings” (HOSTSERVER-706).
- A space change history entry is now made when a Space is deleted (HOSTSERVER-705).

### 15.1.11 3.7.1 (2017-06-20)

This is the initial public release of version 3.7.

This version requires the YVVA runtime 1.4.0 or later.

#### Host Server Functionality

- The Host Server supports Point-in-Time recovery. Using this functionality the TeamDrive Client is able to rollback a Space to a previous point in time. See details in chapter *Snapshot Backup and Point-in-Time Recovery* (page 43).
- Added “Outgoing Connection” settings: `UseProxy`, `ProxyHost`, `NoProxyList`, `ConnectionTimeout` and `NetworkTimeout` (see `outgoing_connections`) (HOSTSERVER-676).
- Added support for Read Notifications. Read Notifications are disabled by default for all Spaces. This feature must be explicitly enabled for a Space by the TeamDrive Client.  
  
The setting `DefaultReadNotificationMaxAge` determines the maximum age of read notifications, if this value has not been explicitly set at the Space level settings (HOSTSERVER-681).
- Fixed a bug which caused an error when moving a Space from one depot to another using the Admin Console (HOSTSERVER-680).
- When accumulating traffic, the process now checks the access time to ensure that traffic is only accumulated for the current month. This fixes the problem that the Object Store log processing can generate traffic changes that occurred in the previous month (HOSTSERVER-702).

#### Administration Console

---

**Note:** Please clear the browser cache after the server update.

---

- Snapshot relevant parameters can be set per Space. Changes are recorded in the change history of the Space.
- Read Notification settings can be set per Space. Changes are recorded in the change history of the Space.
- Added the list of background tasks (“Auto Tasks”) to the Admin Console. The list indicates when a task last ran and the result. Clicking on a task allows the user to Activate or Deactivate tasks (HOSTSERVER-697).

This page also shows the status of the Host Server services: `td-hostserver`, `s3d` and `tshs` (if active). The command used to determine the status is:

```
service td-hostserver/s3d/tshs status
```

If this system is not correctly installed an error will be displayed.

## 15.2 Change Log - Version 3.6

### 15.2.1 3.6.3 (2017-02-15)

- Admin Console: Fixed the select owner dialog on the “Space Depots: Details” page. Entering a name filter was not working (HOSTSERVER-664).

- Revised chapter Host Server Virtual Appliance with CentOS 7

### 15.2.2 3.6.2 (2017-01-24)

- Missing BLOBs are now logged a Trace level (HOSTSERVER-648).
- Added path and BLOB name to error log output of the v2 protocol (HOSTSERVER-649).
- Updating a Depot in the Hosting Server Admin Console could fail with the error: “Owner is empty” (HOSTSERVER-646).
- Fixed incorrect XML sent in the Reg Server search call used to retrieve owner/user details (HOSTSERVER-650).
- Removed “Space has been disabled” messages from log (HOSTSERVER-647).

### 15.2.3 3.6.1 (2016-11-15)

- The Host Server now retrieves details of Owners from the Registration Server. The email address and Provider Code of the Owner will be updated within 24 hours if changed in the Registration Server. So-called “magic usernames” are now only displayed when the Host Server has no email address for a user (HOSTSERVER-629).

See *Sync Owner Data Task* (page 26) for details.

- When adding a Space Owner in the Admin Console, the Host Server will now check that the user is a registered TeamDrive User. Note that that it is now possible to add an Owner by specifying the Email address only (HOSTSERVER-640).
- The statistics poll method now returns the Space owner details to the TeamDrive Client (HOSTSERVER-639).
- Admin Console: fixed error handling when creating an Owner using the Admin Console.
- Admin Console: fixed an error when using the Admin Console to create a new Depot.
- The Client will now be prevented from inserted Space meta data with zero length (HOSTSERVER-644).
- It is now possible to set the system settings `ServiceHostURL` and `RegServerURL` to the domain name of the Host Server or Registration Server instead of a complete URL. The Host Server will not automatically convert this to a URL as required (HOSTSERVER-645).

The setup process of the Host Server will continue to set these values to complete URLs, although the input fields during setup only require domain names.

### 15.2.4 3.6.0 (2016-09-01)

The Host Server 3.6 requires the YVVA runtime version 1.3.8 or later. Please follow the upgrade instructions in *In-place Upgrading from 3.0.013 or 3.5 to 3.6* (page 70)

#### Host Server Functionality

- Improved restore functionality (HOSTSERVER-635).
- The name of the user and the deletion time are now recorded when a Space is deleted (HOSTSERVER-507).  
Note: this only works if TDP v3 is active, and you are using TeamDrive client version 4.2 or later.
- Added system settings: `NotifyVolumeEmail`, `NotifyVolumeWarningLevel`, `NotifyVolumeCriticalLevel`. The background task, Volume Warning, has been added to send an email notification when the the disk usage of a volume exceeds the specified levels.
- Fixed upgrade from version 3.0.011 (HOSTSERVER-618).



- Added the setting `S3RedirectProtocol`. This setting determines the protocol to be used for redirects to S3, or other Object Stores (HOSTSERVER-622).
- Added support for Azure blob storage (HOSTSERVER-583)
- The Host now supports the “Range” header (HOSTSERVER-577). This enables the direct streaming of videos. Note, only one range per call is supported.

### Administration Console

- Added functionality to restore a deleted space (HOSTSERVER-633).
- Host Server settings have now been divided into groups (HOSTSERVER-574).
- The modification time of settings is now displayed in the Admin Console (HOSTSERVER-575).

### API

- Added `movespace` API call, which moves a Space to another Depot (HOSTSERVER-636).
- The `getspacedata` API call now accepts the following additional tags: `<includedeleted>`, `<resultoffset>` and `<resultlimit>` (HOSTSERVER-461).
- The `getdeptdata` API call now accepts the tags `<includedchanges>` which specifies if the change history should be returned with the details of the Depot (HOSTSERVER-497).

## 15.3 Change Log - Version 3.5

### 15.3.1 3.5.8 (2016-09-27)

- Fixed problem when using directory scan on XFS with CentOS7. The “teamdrive-volume-id” file was not being correctly created (HOSTSERVER-643).
- The volume ID is now checked on startup of the Apache module (`mod_pspace`). Previously it was only checked when a Space was created.

### 15.3.2 3.5.7 (2016-08-29)

---

**Note:** The Host Server version 3.5.7 requires YVVA runtime version 1.3.8 or later.

---

---

**Note:** Updating the Host Server on CentOS 7 with “yum update” might update the apache to a newer version. This update could re-install the deleted “conf”-files in the folder `/etc/httpd/conf.modules.d/` and will prevent starting the apache. Please follow the modified instruction to disable all modules in the “conf”-files instead of deleting them as described in `configure-apache-24`

---

- Fixed the “back” button after clicking on a link in the Admin Console.
- Fixed restore function: it was possible that an incorrect log offset was calculated after restore (HOSTSERVER-632).
- Organised the settings into groups in the documentation (HOSTSERVER-630). The same grouping is used in the Admin Console in Host Server 3.6.
- The Depot document returned with `SERVERFLAGS=` contained an invalid terminator. This caused the document to be incorrectly interpreted by the Client and Registration Server (HOSTSERVER-631).

### 15.3.3 3.5.6 (2016-07-13)

- Fixed the traffic reset task. If the setting `StatisticRest` is blank, then the task does not run. A quick workaround for this bug is to set the variable to “0”. This must be done directly in the database, on the table `pspace.Setting`, column `Value` (HOSTSERVER-623).

### 15.3.4 3.5.5 (2016-06-09)

- Added missing `yvva` compatibility to `td-hostserver` background task configuration file

### 15.3.5 3.5.4 (2016-06-07)

---

**Note:** The Host Server version 3.5.4 requires YVVA runtime version 1.3.6 or later.

---

- Fixed a bug that could result in the TeamDrive Client reporting traffic limit reached, when `EnforceTrafficLimit` is set to `False` (HOSTSERVER-621).
- Added support for CentOS 7 with Apache 2.4
- Fixed the link in to Volumes in the Host overview page (HOSTSERVER-619).
- Fixed dialog used to set the owner of a Depot (HOSTSERVER-616).
- Minor API documentation fix: the position of the `<etl>` tag has been changed, and the order of tags in reply’s now matches the order returned by the server (HOSTSERVER-496).
- Admin Console: The Storage and Transfer columns incorrectly showed “MiB MB” as units (HOSTSERVER-612).
- The Host Server was incorrectly setting the Volume full Status bit on Spaces, when the Depot disk limit was reached (HOSTSERVER-611). This error will be corrected automatically.
- Fixed a bug that prevented long running MD5 checks from working correctly.
- An error in the TDP version 3 prevented files from being deleted when the depot was full (HOSTSERVER-610).

### 15.3.6 3.5.3 (2016-02-02)

- Fixed lost password functionality in admin web interface (HOSTSERVER-604).
- Added the `DownloadContentType` setting which may be used to specify the content type of encrypted data returned by Host Server (HOSTSERVER-602).
- API function “`deletespace`” no longer returns an error when deleting a Space that has already been deleted. However, the API also does not return an error if the Space does not exist at all, or if the Space is in another Depot. In these cases, the delete call is just ignored (HOSTSERVER-429).
- Fixed a bug in `mod_pspace`: if a recently published file was deleted and then published again, the result could be that the file on the server has 0 bytes (HOSTSERVER-601).
- The tags `<disclimit>` and `<trafficlimit>` in the “`setdepot`” call are now optional.
- Added `<etl>` tag to the “`getspacedata`” API-call. The “Traffic Limit Reached” bit will also be removed from the status returned by this call (HOSTSERVER-411).

### 15.3.7 3.5.2 (2015-12-08)

- Fixed bug in schema definition for FileSize column in PublicFile table
- Fixed bug with comparison of timestamp to DATE value in the database because of daylight savings time corrections (HOSTSERVER-578).
- Fixed TD3 Protocol crash in loadSpaces() (HOSTSERVER-580).
- Fixed return of .tdsv files
- Fixed disk usage calculation error in case of host server is connected to an object store (HOSTSERVER-576).
- Fixed duplicate object store log files processing in case of identical or missing S3ToProcessPath and S3ProcessedPath (HOSTSERVER-586)
- Fixed adding external traffic in API-call “getspacedata” (HOSTSERVER-587)
- Fixed retrieval of public file where name contains reserved URL characters (HOSTSERVER-581)
- Correctly log last.log.lock when reading and writing log files and if no maximum len is given, return the entire log
- Fixed error when adding MOVE action to database → Illegal mix of collations (HOSTSERVER-589)
- Fixed TD3Protocol: Empty reply for getblob (HOSTSERVER-595)
- Fixed exclude “Error getting size from ...” in case of zero download for object store access log processing (HOSTSERVER-593)
- Corrected RepositoryChanges table duplicate constants
- S3Daemon: Fixed error ‘The Content-MD5 you specified did not match what we received.’ It was possible that the checksum value stored in the database did not match that of the actual file (HOSTSERVER-591).
- S3Daemon: Fixed problem with multipart uploads. If an attempt to transfer a zero length file to S3 it would fail but would try again later so it was stuck in an endless loop (HOSTSERVER-588).
- Added Functionality to move space from one depot to another. The host Admin Console now provides a “Move...” button which can be used to move Spaces to a selected Depot. A new API function, movedespaces(), allows the same function to be performed via the API (HOSTSERVER-546). Client version 4.1.2 required to update the new space owner correctly.

### 15.3.8 3.5.1 (2015-10-09)

#### Documentation

- Fixed description of Background Tasks
- Added ssl configuration hint in case of upgrading a server to version 3.5
- Added description for the html templates for password protected published files

#### Host Server Functionality

- Usability: Added a default html template folder to avoid conflicts with customized html templates (HOSTSERVER-572)
- Administration: Fixed divide by zero error in case of depot size and traffic limit are zero (HOSTSERVER-570)
- Administration: German translation is disabled. Only english web interface is supported (HOSTSERVER-569)

- Administration: The new background task for API log cleanup will be created with status enabled instead of disabled. The usage could be controlled using the setting “APILogEntryTimeout” (HOSTSERVER-568)
- Usability: Added html template “url-invalid.html” for expired or invalid token in case of access a published file (HOSTSERVER-567)
- Security improvement: Limit access to allowed log files (HOSTSERVER-564)
- S3 daemon: Added bandwidth limitation for the S3 daemon (HOSTSERVER-563)
- Administration: Added filter (<, >, =) for Space-IDs and Depot-IDs (HOSTSERVER-562)
- Administration: Added setting “APILogEntryTimeout” to define a period in days for deleting api logs (HOSTSERVER-561)
- Administration: Fixed truncated “Add New Admin User”-Button (HOSTSERVER-560)
- Administration: Fixed access to ping.xml (HOSTSERVER-558)
- Administration: Fixed s3d.log file name for log file display (HOSTSERVER-557)
- S3 daemon: Fixed crash in case of multipart upload (HOSTSERVER-556)
- Administration: Fixed displaying info text for “TimeDiffTolerance” setting (HOSTSERVER-553)

### 15.3.9 3.5.0 (2015-09-21)

TeamDrive Host Server Version 3.5 is the next major release following after version 3.0.013.

---

**Note:** Please note the the version numbering scheme for the Host Server has been changed starting with version 3.5. The first two digits of the version string now identify a released version with a fixed feature set. The third digit, e.g. “3.5.1” now identifies the patch version, which increases for every public release that includes backwards-compatible bug or security fixes. A fourth digit identifies the build number and usually remains at zero, unless a rebuild/republishing of a release based on the same code base has to be performed (e.g. to fix a build or packaging issue that has no effect on the functionality or feature set).

---

Version 3.5 contains the following features and notable differences to version 3.0.013. See [releasenotes-3.0.013](#) for a detailed description of the change history for that version.

#### Host Server Functionality

- Security enhancement: Files can now be published with an expiration date after which an auto task on the Host Server will automatically remove the published files again. Additionally, published files can now be protected by a password. This functionality requires support on the TeamDrive Client side, which is implemented in versions 4.1 of the TeamDrive Client. For entering the password in a html page, a few templates were added. The templates could be customized and will not overwritten when updating to a newer Host Server version.
- Security enhancement: A request for a published file no longer returns the actual file directly, except in the case where the request comes from tools like `wget` or `curl`. Instead, the document returned is an HTML file containing JavaScript calls that load the actual file using a temporary URL. This solves a potential security problem in which URLs of published documents can be inadvertently disclosed to unintended recipients in the following scenario: A TeamDrive user publishes a document that contains URLs pointing to a third-party website (e.g. a PDF or office document). The user, or an authorized recipient of the published URL, clicks on a hyperlink embedded in the document. At that point, the referrer header discloses the document’s publish URL to the third-party website. Someone with access to that header, such as the webmaster of the third-party website, could then access the link to the published document. (HOSTSERVER-316)
- A new Client/Server protocol, supporting parallel polling of Spaces for increased throughput/performance, batched delete operations (e.g. emptying the Trash) and “soft” locking of files. These features require support on the TeamDrive Client side, which is scheduled to be implemented in future versions of the TeamDrive Client.

- Performance improvement: The Host Server now uses a database table instead of action files in the Space Volume's file system for signalling actions like uploading or deleting files to the object store. As a result, `s3d` no longer has to perform a full scan of all Space Volumes to look for new or changed files. (HOSTSERVER-284) Additionally, the MD5 digest of a file is also stored in this table, so `s3d` does not need to perform a recalculation of the checksum before uploading the file to the object store. During an upgrade from a previous version, any remaining action tag files in the file system will be imported into the database. Afterwards, the server setting `ImportS3tagFiles` should be set to `False`.
- The S3 daemon `s3d` now only performs a full scan of all Space Volumes once per day by default, looking for old files to be transferred to the object store. The age of these files is set via the settings variable `MaxFileAge`. The maximum file age should be set long enough to ensure that no file that may still be in the process of being uploaded by a Client will be sent to the Object Store, otherwise the Client would have to restart the upload from scratch.

## Administration Console

- Security improvement: Added support for managing multiple user/administrator accounts. There are 2 types of users: Superuser and Administrator. Only the Superuser may manage other users. The Administrator may view all users and only update his own user account. (HOSTSERVER-366)
- Security improvement: Disabled auto completion on the login form. (HOSTSERVER-379)
- Security improvement: The complexity of entered passwords is now indicated. (HOSTSERVER-374)
- Security improvement: it is now possible to enable two-factor authentication via email. If enabled, the user is required to enter a security code provided via email in addition to his username and password.
- Security improvement: On login, the user will get an error if he has another logged in session. To proceed, the user must check the checkbox titled: "Close my other login sessions". (HOSTSERVER-376, HOSTSERVER-377)
- Security improvement: The following events are now logged at the "notice" level: login, logout, failed login attempts and changes to user accounts.
- Security improvement: the amount of search results (e.g. Spaces, Depots or users) is now limited to a maximum defined by the `MaxRecordsDisplayed` setting, which can only be changed by the Superuser.
- Administration: It is now possible to change a Depot's status (e.g. enabled, disabled, deleted)
- Administration: Added support for viewing selected server log files and the Host Server API log. (HOSTSERVER-348, HOSTSERVER-243)
- Administration: It is now possible to track and display modifications made to Space Depots (e.g. via API calls coming from the Registration Server or via the Host Server Admin Console). (HOSTSERVER-388)
- Administration: When creating a new Space Volume via the Administration Console, the system now checks if the directory actually exists on the file system before creating the Volume. (HOSTSERVER-349)
- Usability: References like Depot Names, Volume names and owners in the Space list are now clickable, to improve the quick navigation between pages. (HOSTSERVER-390)
- Usability: Objects like Spaces or Depots that have been marked as deleted are now hidden in result lists by default. They can be made visible again by changing the setting `ShowDeletedObjects` from `false` to `true`. (HOSTSERVER-442)
- Usability: Administration Console now better visualizes errors like missing Space Volumes.
- Usability: Units displayed for disk space or traffic usage now use the correct units (e.g. MiB, or GiB), to avoid confusion caused by conversions between different units. Space and traffic levels are now displayed in percent instead of absolute units.

### Administration / Installation

- Administration: The Host Server's log levels have been aligned with the ones used by the Registration Server and the Yvva Runtime Environment. Valid log levels are: 1 (Error), 2 (Warning), 3 (Notice), 4 (Trace), 5 (Debug). In production mode the default log level is 3 (Notice). Setting the log file name to `syslog` will now send log output to the local syslog service. You can add an optional "Log Identity" after a colon in the log file name, for example: `syslog:my-log-id`. The default Log Identity is name of the program, e.g. `s3d` or `tshs`.
- Administration: The central log file `/var/log/td-hostserver.log` is the central log location for all Yvva-based components (e.g. the Host Server API, Administration Console or `td-hostserver` background service); the log files used in previous versions (e.g. `/var/log/mod_yvva.log`, `/var/log/pl_autotask.log`, `/var/log/pbvm.log`) will no longer be used.
- Administration: TSHS now supports the additional commands `disable-s3-host`, `enable-s3-host` and `delete-s3-host` that allow for disabling/removing the synchronization of objects to an S3-compatible object store. Calling `disable-s3-host` marks a host entry as "disabled". Calling `delete-s3-host` deletes a host entry unless the entry is referenced by a file. In this case the entry will be marked as deleted. If an entry is marked as disabled or deleted, no further data will be uploaded to the object store. However, accessing existing objects from the object store will continue to work. Calling `enable-s3-host` will re-enable the synchronization of objects to the object store, including the upload of all objects that have been uploaded to TSHS while the object store was marked as disabled. If a disabled or deleted host is marked as current, then TSHS will generate an error on each write attempt.
- Administration: Added an auto task that can be enabled to send out notification emails if a Space Volume's disk utilization reaches a configurable level.
- Administration: Added an auto task that removes published files that have reached their expiry time.
- Administration: Added an auto task that can be enabled to delete API log entries older than 30 days from the `hostapilog` table.
- Installation: TSHS now supports reading options from a configuration file. The default is `/etc/tshs.conf`. The default options that were previously stored in the TSHS init script `/etc/init.d/tshs` have now been moved to the configuration file instead. (HOSTSERVER-303)
- Installation: Optionally configure email support (required when using two-factor authentication). (HOSTSERVER-437)
- Installation: The initial Host Server setup process now asks for both a user name and password for the Superuser account. (HOSTSERVER-438)
- Installation: Host Server 3.5 now requires Yvva Runtime Environment version 1.2 or later. This version is included in the Host Server's yum package repository and will be installed automatically.
- Installation: The distribution now contains the tool `mys3`, which can be used to interact with an S3 compatible object store.

### API

- Changes to a Space Depot performed by the API functions `addusertodepot` and `deleteuserfromdepot` are now added to the Depot's change log.
- The MD5 checksum value calculated over API requests no longer needs to be passed in lowercase when submitting the request. (HOSTSERVER-426)
- For debugging purposes, erroneous API requests are now logged to the API requests table as well. (HOSTSERVER-465)

## 15.4 Change Log - Version 3.0.013

### 15.4.1 3.0.013.15 (2015-08-17)

- S3: Fixed bug with high IO, upload could not proceed and other uploads will be blocked. (HOSTSERVER-529)

### 15.4.2 3.0.013.14 (2015-06-04)

- S3: Fixed bug in parsing S3 access log entries for traffic calculation (resolves Error getting spaceid errors in `td-hostserver.log`). Additionally, the S3 log analyser script now only downloads and processes objects from the log bucket that contain the string `access_log-`. (HOSTSERVER-500)
- `mod_pspace`: Added support for calculating traffic from S3-compatible object stores that do not support access logging via log buckets in the way that Amazon S3 does it. Now, if a redirect to S3 is performed and `S3LogBucketName` has not been specified, the request length will be logged as bytes sent. (HOSTSERVER-499)
- `s3d`: The S3 daemon has now been split into two processes, a worker process and a watchdog process. If the worker process dies, the watchdog will restart it. Killing the watchdog process will also kill the worker process. The watchdog will always try to restart the worker, but depending on the frequency with which the worker is dying the watchdog will wait before trying to restart it. The minimum wait is 3 seconds, the maximum is 30 minutes. (HOSTSERVER-508)

### 15.4.3 3.0.013.13 (2015-05-11)

- `mod_pspace/s3d`: Added workaround to handle a deviation in the Ceph 0.8 Object Store S3 API: the “list multipart upload parts” API request returns `ListMultipartUploadResult` instead of `listpartsresult` (see BUG#11494 in the Ceph bug tracker for details). (HOSTSERVER-484)
- `mod_pspace`: Added missing call to `s3d_delete()` when an “Upload to file that has already been transferred to S3” is detected. Due to the missing call, Clients could end up in an endless loop, showing a “wrong md5” error in the log file. (TDCLIENT-2045)
- `mod_pspace`: Added new module option `watched_space_id` that can be used to trace Client accesses to a specific Space for debugging purposes. See `tracing_client_accesses_to_a_single_space` for details. (HOSTSERVER-486)

### 15.4.4 3.0.013.12 (2015-04-14)

- `s3d`: Uploading the `last.log` file failed with a checksum error if the log was written to before the upload was complete. `s3d` now only transfers the data size used when calculating the checksum. This will allow the `last.log` file to grow while being uploaded to S3. (HOSTSERVER-474)
- `s3d`: Fixed unsafe object references during multi-part uploads which may have lead to `s3d` crashes. (HOSTSERVER-454)
- Installation: The `td-hostserver` RPM package will no longer reset the permissions and ownerships of the `/spacedata` and `/spacedata/vol01` directories to 700 and `apache:apache` during an update, if they had been changed by the administrator after the initial installation. Depending on how the Space Volume is mounted, the RPM installation could fail with an error like `error: unpacking of archive failed on file /spacedata`. A new installation will still create the directories using these permissions/ownerships by default. (HOSTSERVER-401)
- Host Server: Converted the type of the `StatisticRest` setting from `INT` to `DATE`, to avoid an error that could occur when updating from very old Host Server Versions (the `resetTraffic()` auto task failed with an `Invalid integer literal error`). This also fixes a potential issue that could result in the reset routine being run multiple times on the day the traffic is reset. (HOSTSERVER-478)

- Documentation: Fixed link structure in the HTML documentation so that clicking **Next** and **Previous** within a document works as expected. (HOSTSERVER-471)

### 15.4.5 3.0.013.11 (2015-03-30)

- Administration Console: Updated logo and favicon.
- Host Server: Updated some error messages by replacing “Repository” with “Depot”. Ensure that a Space Depot that has been marked as “Deleted” no longer allows the creation of new Spaces. (HOSTSERVER-456)
- mod\_pspace: Reduced logging of errors by only logging Client accesses to deleted Spaces as an error if the Space status is zero. (HOSTSERVER-449)
- mod\_pspace: Fixed a crashing bug that could occur in rare situations. (HOSTSERVER-457)
- s3d: Fix unsafe access to the thread pool that may have caused s3d to crash in certain situations. (HOSTSERVER-454)
- s3d: Fixed a problem that caused a crash if a multipart upload was interrupted before completion and then restarted again. The parts list could have holes in it for the parts that were successfully uploaded in the first try.
- Documentation: Added section that instructs the user to perform a `yum update` after installing the VM image. Reformatted the 3.0.013 release notes and replaced the table with regular sections for improved readability.
- Documentation: Added Failover and Scalability chapter to the Administration Guide, added description of the startup sequence/dependencies to the Installation Guides. (HOSTSERVER-431)

### 15.4.6 3.0.013.10 (2015-01-26)

- s3d: Fixed a problem that caused a crash from time to time. The crash would occur if a request for an object’s header timed out or was interrupted.
- Host Server: Fixed bug in the calculation of `DiskUsed` for Space Volumes that did not contain any Spaces. (HOSTSERVER-452)
- Administration Console: The Volume repair button now only appears if a repair is actually required (previously it appeared whenever there was an error on the volume).
- Installation: added a new RPM package `td-hostserver-doc-html` that contains the Host Server documentation in HTML format, installed in the Host Server’s Apache document root `/var/www/html/td-hostserver-doc/`. Access to the documentation can be restricted by editing `/etc/httpd/conf.d/td-hostserver-doc.httpd.conf`. (HOSTSERVER-450)
- Installation: fixed bug in upgrading from older versions and the `hostapilog` database did not get created. (HOSTSERVER-446)

### 15.4.7 3.0.013.9 (2015-01-14)

- mod\_pspace/s3d: fixed unexpected object `"vol01/..."` starting with `'vol'` was found in the `bucket...` error, which prevented the Apache module from starting. This error could occur after updating from a previous version if S3 was already enabled, and the old object format (prefixed by volume name) was used on an S3 compatible object store. (HOSTSERVER-447)

### 15.4.8 3.0.013.8 (2015-01-13)

- API: Added missing `activatedepot` API command and added new tag `<changeinfo>` to add a free form comment to the change history of the following API commands: `activatedepot`,



`assignusertodepot`, `createdepotwithoutuser`, `deactivatedepot`, `deletedepot`. Updated API version to 3.0.004. (HOSTSERVER-337)

- Installation: fixed typo in the installation script that adds the RewriteRules to `ssl.conf`. Added RewriteRule in preparation for accepting Client requests for Space data via SSL/TLS (not supported yet).
- Installation: the binary tarball distribution now includes debug versions of the Host Server binaries (`s3d-debug` and `tshs-debug`) and Apache module (`mod_pspace-debug.so`, to better support analyzing possible crashing bugs. (HOSTSERVER-445)
- Installation: fixed possible upgrade error from previous versions: moving the MySQL table `pbpg.Keys` to the `pspace` database failed if an empty `pspace.Keys` table already existed. (HOSTSERVER-441)

### 15.4.9 3.0.013.7 (2014-12-12)

- Fixed error in creating an index during the initial MySQL table creation (HOSTSERVER-440)

### 15.4.10 3.0.013.6 (2014-12-09)

- Installation: fixed possible upgrade error from 3.0.011 when the MySQL database `pbpg` still existed, but the `Keys` table was already moved to the `pspace` database (HOSTSERVER-427)
- Fixed bug in which failed Auto Tasks were not executed anymore (HOSTSERVER-407)
- `mod_pspace`: fixed possible crash when system settings are NULL (e.g. in an upgrade scenario from 3.0.011 to 3.0.013, when `httpd` was started before `yvvd` performed the required schema updates)
- `mod_pspace`: Fixed possible “Admin API: AES decode error- corruption detected” error when updating from older versions (timing issues could result in the generation of duplicate private keys) (HOSTSERVER-420, HOSTSERVER-422)
- Increased the size of the `S3Options` settings field from 200 to 2000 chars, to accommodate longer option strings required for certain OpenStack environments (HOSTSERVER-425)
- Installation: updated `RewriteRule` sets in the `httpd` configuration files (removed obsolete `/depot` rule, HOSTSERVER-424)

### 15.4.11 3.0.013.5 (2014-09-26)

- `mod_pspace`: fixed a Space corruption bug that could occur when updating from a previous Host Server version to version 3.0.013 and Space Volumes were using a non-standard naming scheme (not “volxxx”)
- Admin Console: added “Repair” button that allows performing an automatic repair of Volumes affected by the corruption bug. Clients will be notified to perform a Space Restore operation on affected Spaces.

### 15.4.12 3.0.013.4 (2014-09-18)

- Admin Console: fixed 404 errors when opening the Admin URL without a trailing slash (HOSTSERVER-398)
- Admin Console: the input focus is now automatically set to the password field (HOSTSERVER-392)
- `s3d`: Fixed bug in path deletion on S3: if the path ended with `/` it wasn't being deleted.
- `s3d`: exceptions are now logged in `/var/log/s3d.log`

### 15.4.13 3.0.013.3 (2014-09-05)

- `mod_pspace`: Replaced the previously used MD5 implementation with calls to the MD5 routines provided by OpenSSL (yielding a 70% performance improvement when calculating MD5 checksums on large files) (HOSTSERVER-355)
- `mod_pspace`: consolidated brand-specific settings into one place and disabled multi-part uploads for Open-Stack
- `mod_pspace`: Fixed bug where failed uploads (resulting in MD5 checksum failures) would still be accounted for as bytes written in the Space usage statistics (HOSTSERVER-352)
- Fixed autotask `resetTraffic()` to properly reset the traffic for Spaces that had the `SPACE_TRAFFIC_FULL` status flag enabled. (HOSTSERVER-353)
- Installation: security enhancement: set `ServerTokens` to `Prod` and `ServerSignature` to `Off` in `httpd.conf` to disable displaying the Apache Server version and OS version in the HTTP headers and on error pages (HOSTSERVER-357)
- `mod_pspace`: Disabled unnecessary buffering of files fetched from S3 object store and passed back to the client. (HOSTSERVER-356)
- `tshs`: `add-s3-host` will ping the S3 service before actually adding the host details.
- Admin Console: security enhancement: don't display the version and build number on the login page and `https` redirection page (HOSTSERVER-359)
- Security enhancement: disabled unneeded HTTP methods in `td-hostserver.httpd.conf` (only allow GET, POST, PUT, disable HEAD, OPTIONS, TRACE) (HOSTSERVER-361)
- Virtual appliance security enhancement: set `ServerTokens` to `Prod` and `ServerSignature` to `Off` in `httpd.conf` to disable displaying the Apache Server version and OS version in the HTTP headers and on error pages (HOSTSERVER-357)

### 15.4.14 3.0.013.2 (2014-07-14)

- To avoid confusion, the S3-related configuration option `openStackAuthURL` was renamed to `openStackAuthPath`

### 15.4.15 3.0.013.1 (2014-07-11)

Host Server Version 3.0.013 is the next major release following after version 3.0.011 (Version 3.0.012 was an internal release that has not been published).

Version 3.0.013 contains the following features and notable differences to version 3.0.011:

- The TeamDrive Host Server installation can now be performed via RPM on Red Hat Enterprise Linux 6 and derivative distributions, which significantly improves the installation procedure and the process of applying updates.
- The initial setup and registration of a Host Server is now fully web-based. It's no longer necessary to provide a `hosting.txt` or `properties` file. Instead, all the required information can be entered in a web form.
- The entire Host Server configuration is now stored in the MySQL database. This includes configuration settings for S3 daemon and TSHS.
- The web-based TeamDrive Hosting Service Administration Console has been improved significantly, by simplifying the work flows for common administration tasks and fixing several usability issues.
- TSHS, the TeamDrive Scalable Hosting Storage and the TeamDrive S3 Daemon provide additional scalability options to expand the storage capabilities of a TeamDrive Hosting Service.
- It's now possible to generate a monthly report that contains detailed statistics about all existing Depots and Spaces within these depots, including the monthly traffic and disk usage.

- The Host Server no longer depends on the PrimeBase Application Environment. Instead, it now uses the Yvva Runtime Environment, which replaces the following components:
  - `mod_yvva` replaces `mod_pbas` for providing the web-based Administration Console and API. The stand-alone `pbas` instance is no longer required. As a consequence, the `pbur` MySQL database which was used by PBAS to manage user accounts and privileges is no longer required and has been removed.
  - `yvvad` replaces `pbac` for running background tasks. The former `p1_autotask` background task PBAC instance is now provided by the service `td-hostserver`, which uses `yvvad`.
  - `yvva` replaces `pbac` for command line operations that involve executing PBT code on the shell.
- The installation location of the TeamDrive PBT code has been changed from `/home/teamdrive/pbas` to `/opt/teamdrive/hostserver/`.
- The `sakgen` binary that used to be installed in `/home/teamdrive/sakh` is no longer required. Instead, the functionality to encrypt Space Depot access keys is now provided by the `tshs` binary.
- All TeamDrive Host Server processes now run under the user ID used by the Apache http Server (`apache`). A dedicated `teamdrive` user account is no longer required.
- By default, the MySQL databases are now installed in the default location `/var/lib/mysql` instead of `/spacedb`, which made it difficult to enable SELinux on the MySQL instance.
- For security reasons, the MySQL credentials required for accessing the MySQL Database are no longer stored in the default MySQL configuration file `/etc/my.cnf`. Instead, the `[p1db]` options group has now been moved into a dedicated configuration file `/etc/td-hostserver.my.cnf`, only readable by the `apache` user.
- The Apache `httpd` Server configuration file has been renamed from `teamdrive.conf` to `td-hostserver.httpd.conf`.
- The overall robustness of the TeamDrive Host Server has been improved by issuing more meaningful error messages and performing more safety and consistency checks.
- Each Space Volume now contains a file `teamdrive-volume-id` that contains a unique global volume ID, to ensure that multiple volumes are mounted to the correct location.

## 15.5 Change Log - Version 3.0.011

### 15.5.1 3.0.011.6 (YYYY-MM-DD)

- HOSTSERVER-228: Add settings for `ClientPollFrequency` and `StatisticPollFactor`
- HOSTSERVER-241: Moved `[p1db]` group from `my.cnf` to a dedicated configuration file `/etc/td-hostserver.my.cnf` to improve security and packaging.

### 15.5.2 3.0.011.5 (2014-04-22)

- HOSTSERVER-224: Added `SpaceStatisticEnabled` and `SpaceStatisticExportPath`
- Updated `teamdrive.conf` Apache configuration file: wrapped long lines and updated `s3daemon` file locations to match the defaults suggested in the Installation Manual
- HOSTSERVER-191: Fixed Magic Username problem with `sakgen` by enclosing them with single quotes to avoid the shell from expanding them as variables. Fixed “bad file descriptor error”

### 15.5.3 3.0.011.4 (2014-03-12)

- Fixed HOSTSERVER-99: created database migration script `mysql/v3.0.010_to_v3.0.011.sql` to update the table structures, move the Keys table from database `pbpg` to `pspace` and renamed database `td2apilog` to `hostapilog`.
- Removed default `API_SALT` in sql script.
- Improved `hosting.txt` value validation.

### 15.5.4 3.0.011.3 (2014-03-03)

- Updated version number in `pbstab` from “4546” to “4547”
- Fixed HOSTSERVER-172: The default MySQL table definition file `mysql/plspace_schema.sql` contained a wrong value for the configuration variable `PathToSAKConverter`. Instead of `/home/teamdrive/sakh/sakgen` it should have been `/home/teamdrive/sakh/`.

### 15.5.5 3.0.011.2 (2014-02-07)

- Updated sample `hosting.txt` file: no trailing slash after `REGSERVERURL`
- Updated and completed Translation files (grammar, typos, obsolete terms)
- Set `PathToSAKConverter` configuration variable to `/home/teamdrive/sakh/sakgen` by default
- Added S3Daemon config and script files to the installation package
- Fixes to object store access log processing

### 15.5.6 3.0.011.1 (2014-02-04)

- Added parsing and error handling for `API_IP_LIST` and `API_SALT` from the `hosting.txt`.
- `pbstab`: changed log file from `/home/teamdrive/pbas/setup/pbac.log` to `/var/log/pl_autotask.log` (HOSTSERVER-145)
- `pbstab`: fixed wrong path to `plctl.dal`
- Fixed setting space status bit
- Fixed autotask debug output
- Fixed typos and obsolete reference to `plctl` from the translation files
- Changed configuration variable 340 “Protocol Log File” in `pbas.env` from “<< Default Log >>” to “`/var/log/pbas.log`” - note that this file needs to be created and assigned to the user running the PBAS instance (`touch /var/log/pbas.log ; chown teamdrive:teamdrive /var/log/pbas.log`)
- Fixed HOSTSERVER-150: removed reference to `td2apilog` database

### 15.5.7 3.0.011.0 (2014-01-28)

- First build of the 3.0.011 branch, using the scripted build

## 16.1 Abbreviations

**PBT** PrimeBase Talk is an object oriented language specifically designed for the programming of “server-side” functionality common to intra- and internet Web sites. A large share of the TeamDrive Host and Registration Server functionality is implemented in PBT. The code is parsed and executed by the Yvva application server components.

**SAKH** Server Access Key HTTP for TeamDrive 2.0 Clients

**TDNS** TeamDrive Name Service

**TDRS** TeamDrive Registration Server

**TDSV** Same as **SAKH**, but for TeamDrive 3.0 Clients: TeamDrive Server

**TSHS** TeamDrive Scalable Hosting Storage.